

Engineering the **5G** World

Design and Test Insights

From Ron Nersesian

Keysight has a long and proud history of helping technology visionaries and innovators solve their toughest challenges to accelerate innovation to connect and secure the world. This heritage traces back to our company's founding by Bill Hewlett and Dave Packard in a Silicon Valley garage. Our name has changed over the years, from HP to Agilent and now Keysight. We carry on this legacy as the world embraces new disruptive technologies, like 5G, at a pace we've never seen before.

In 2014, when we launched Keysight as a standalone company, we made a strong and unwavering commitment to be a market leader in 5G. Our team worked incredibly hard to support customers to make 5G a reality. We have taken a collaborative approach across the ecosystem while also advancing 5G standards and test methodologies. Our team has taken an active role with 3GPP, CTIA, GCF, PTCRB, NGMN, O-RAN Alliance, and other organizations. We have the most 5G NR conformance test cases validated by GCF and PTCRB. Our work on 5G is not yet done.

We remain focused on delivering end-to-end solutions to enable your success. We fully understand the complexity and accelerated timelines 5G presents. At Keysight, we remain committed to strengthen our already differentiated and unmatched portfolio of solutions to ensure your success in 5G.

We value your partnership and look forward to continuing to work together as 5G becomes more widespread. ~Ron



Keysight's contributions enable numerous companies across the ecosystem to make 5G advances and breakthroughs. Since 2015, we've delivered over 20 industry-first 5G solutions:

2015

Accelerated 5G wireless research with the introduction of the 5G Design Library to validate new technology concepts

2016

Enabled first-to-market 5G designs with the first all-in-one software for designing and evaluating 5G candidate waveforms

2017

Enabled 5G prototypes and designs with the 5G Protocol R&D Toolset and 5G RF DVT Toolset, and 5G NR-ready network emulation solutions

2018

Enabled early 5G commercialization with:

- 5G channel emulation solution to validate end-to-end performance
- 5G conformance toolset with PTCRB approval for 5G NR NSA mobile device certification
- 5G base station manufacturing solution to transition to volume manufacturing
- 5G field measurement solution for accurate network planning

2019

Streamlined the workflow for 5G chipsets, devices, and base stations from research to deployment with:

- 5G conformance toolset with GCF approval for 5G NSA mobile device certification
- 5G virtual drive testing toolset to conduct performance testing
- FieldFox handheld analyzer to characterize the 5G air interface



Contents

- Chapter 1 - Book Overview and 5G Applications 7

- Chapter 2 - The 5G NR Standard12
- Chapter 3 - mmWave Spectrum19
- Chapter 4 - Massive MIMO and Beamforming26
- Chapter 5 - Over-The-Air Testing.....32

- Chapter 6 - 5G: The Big Picture.....40
- Chapter 7 - Accelerating 5G NR Designs.....44
- Chapter 8 - Spotlight on 5G mmWave Waveform Evaluation52
- Chapter 9 - Passing 5G NR Conformance.....64
- Chapter 10 - Succeeding at 5G NR Carrier Acceptance70
- Chapter 11 - Preparing for 5G NR High-Volume Manufacturing76
- Chapter 12 - How to Double Test Capacity with Zero Additional CapEx.....80
- Chapter 13 - Solutions that Accelerate 5G Innovation.....82

Chapter 14 - 5G Equipment Challenges	91
Chapter 15 - Accelerating 5G NR MIMO Designs	94
Chapter 16 - Spotlight on 5G Channel Emulation	98
Chapter 17 - Rapid Characterization of 5G Components	110
Chapter 18 - Revising Antenna Designs for New Requirements	113
Chapter 19 - Mastering 5G NR Manufacturing	117
Chapter 20 - Reducing Test Time	121
Chapter 21 - Solutions that Streamline the 5G Workflow	125
Chapter 22 - 5G Networking: An Overview	134
Chapter 23 - Validating the 5G Core Network.....	139
Chapter 24 - Redefining 5G NR Field Testing	147
Chapter 25 - Spotlight on Over-The-Air Performance Testing.....	153
Chapter 26 - Solutions for Designing and Deploying 5G Networks	161
Chapter 27 - Insights Into the 5G Ecosystem	167
5G Terms and Acronyms	170
Technical Contributors.....	181

Section 1

The Promise of 5G

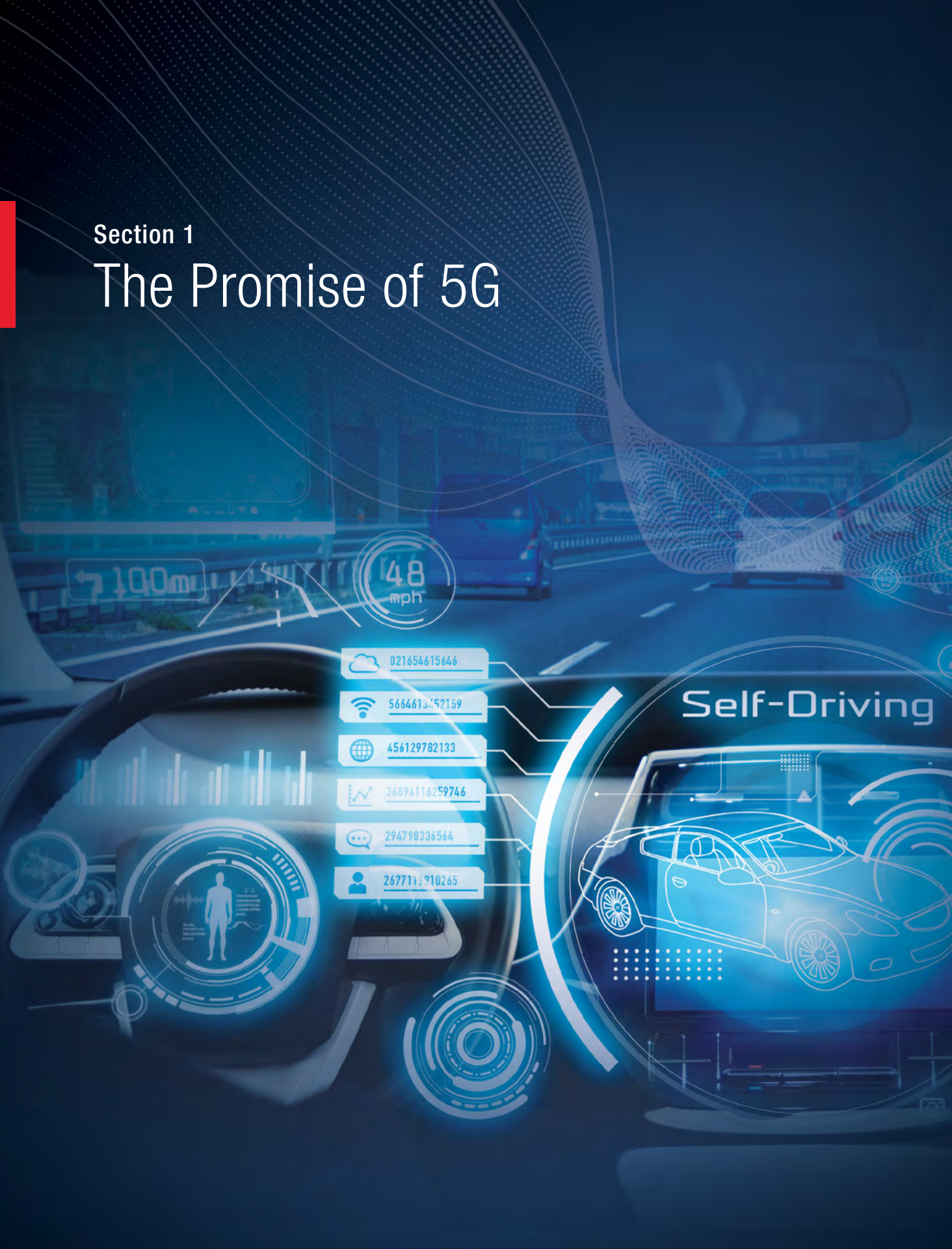

021654615646

5664613452159

456129782133

36896118259746

294798336564

2677119910265

Self-Driving

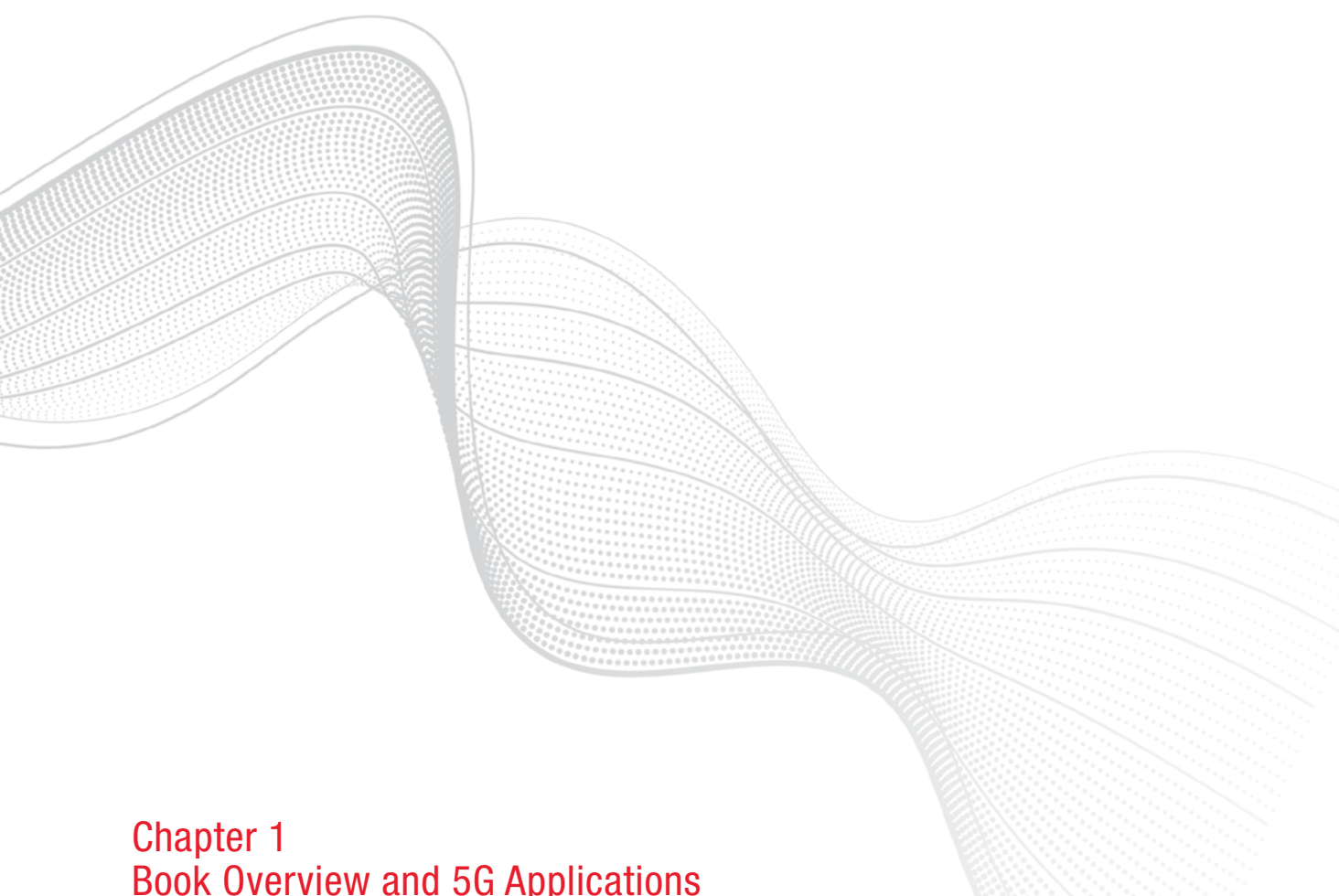

Chapter 1 Book Overview and 5G Applications

5G dominates the technology news, and for good reason. 5G's high-bandwidth and real-time capabilities hold enormous potential for society by enabling many new and unexpected use cases. Virtual and augmented reality, autonomous driving, and the Industrial Internet of Things (IIoT) are some of the exciting applications it will enable. 5G significantly improves our number one communications infrastructure. As one of the developers of 5G, you will be the primary creator, not only of the 5G network and related equipment, but also of many new applications.

This Book is for You

This book provides you with a big-picture overview of 5G technology and should help you better understand your role in this 5G ecosystem. It focuses on test and measurement (T&M) and its role in the development of 5G. As you design 5G hardware and software, you need all the information and insight possible to ensure the success of your contribution. This book delivers the collective distilled wisdom of Keysight 5G experts. Its goals are to:

- summarize the fundamentals of 5G across the entire ecosystem
- introduce you to best practices to test your 5G solutions
- support your work across the entire 5G workflow to ensure your success

Keep in mind that you cannot successfully design, manufacture, or deploy any 5G equipment without the necessary test equipment. And knowing the fundamentals of the 5G standards and test methodologies is equally important.

The Scope of 5G

5G illustrates the breadth and depth of innovative and comprehensive mobile wireless communication technology. The potential of 5G is nearly limitless. Some of the new applications it will enable are:

- virtual and augmented reality
- autonomous driving
- vehicle-to-everything (V2X) communications
- the Internet of Things (IoT)
- the Industrial IoT (IIoT)
- multi-gigabit wireless mobile broadband
- fixed broadband wireless access

The 5G wireless technology is called New Radio (NR). NR is a standard developed by the 3rd Generation Partnership Project (3GPP). The standard's development continues to evolve to reach faster data rates, improved coverage, lower latency, and higher reliability.

The Challenges of 5G

Delivering the kind of wireless speed, responsivity, and reliability promised by 5G requires a series of technical advancements. Furthermore, it requires a significant overhaul of the entire cellular network. Some of the new challenges include:

- new frequency bands like 3–6 GHz and millimeter-wave (mmWave)
- greater synchronization demands on the network driving faster radio access network (RAN) and core network speeds
- a new specification for the air interface
- an updated RAN and core architecture
- interaction with legacy technologies

These factors all drive a disruptive shift in design, test, and measurement techniques. Some are obvious, like the move from conducted test methods to over-the-air (OTA) testing with the advent of mmWave. Others are less obvious, like the demands for testing much higher network speeds in fiber-optic systems and much higher digital data speeds in the electronics to support faster mobile and base station designs. 5G also requires the use of complex coverage and capacity-improvement concepts like massive multiple-input multiple-output (massive MIMO) and beamforming, that drive new test needs for the industry. Figure 1.1 below lists some of the related test challenges.

5G Technical Challenges

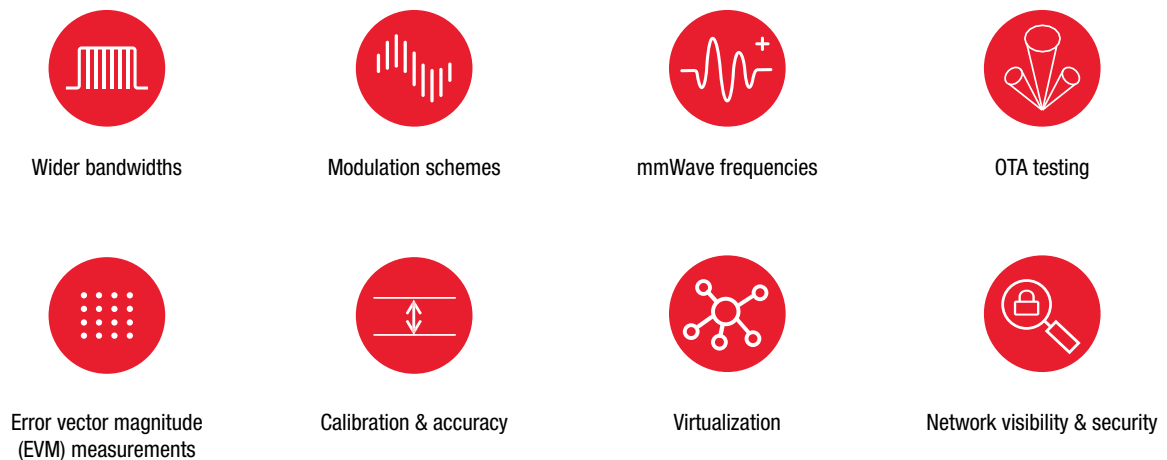

Figure 1.1. Eight critical facets of 5G

Engineers also face added pressure from accelerated timelines. Mobile network operators (MNOs) around the world, eager to deliver new services to consumers, have set ambitious targets for 5G mobile network deployments. They strive to shorten the product and service lifecycle from the laboratory to the field and create new monetization opportunities. This has a ripple effect. Device makers and network equipment manufacturers (NEMs) deliver 5G smartphones and base stations, for which they need technology breakthroughs from chipset manufacturers. Bringing 5G to life requires an ecosystem that is geared up to develop, refine, and deploy the necessary technologies. Figure 1.2 shows the main parts of the workflow for the critical components of the 5G mobile ecosystem.

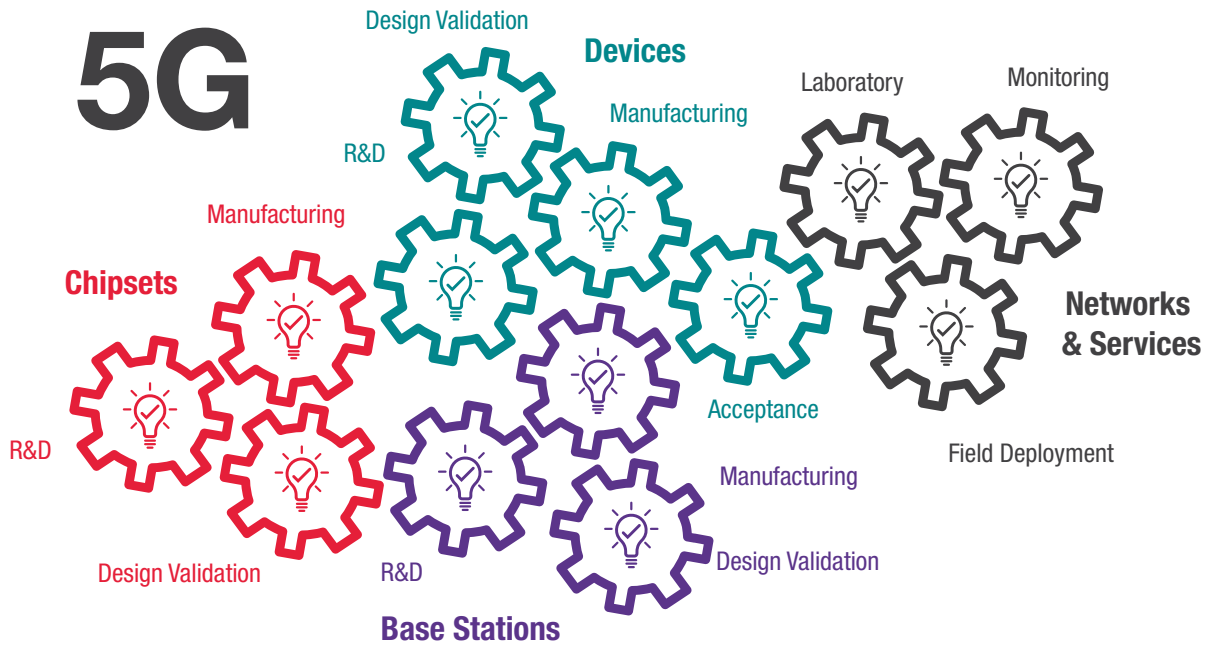

Figure 1.2. The 5G design and development machine

Organization of This Book

The key topics covered in the sections to follow are chipsets and devices, base stations and components, and networks. The content of each section follows the general workflow of technology — from research and development (R&D), design validation, manufacturing, field deployment, and monitoring. You can find more information and new resources at keysight.com/find/5g.



Section 2

Overview of 5G NR Technologies

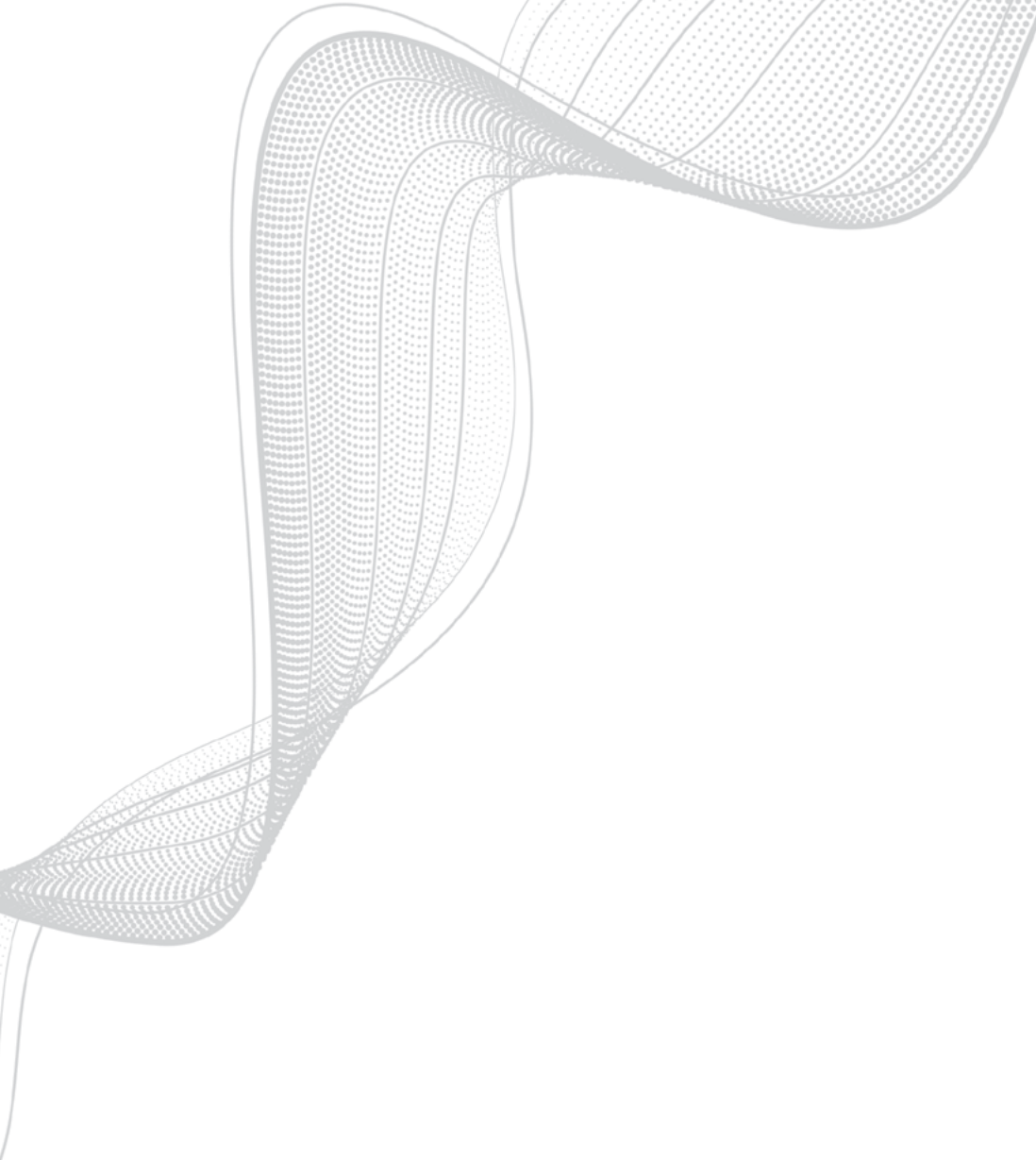

Chapter 2

The 5G NR Standard

5G offers dramatic improvements over 4G's capabilities. The physical layer specifications began with 5G NR initial Release 15. The Release 15 specification focuses on enhanced mobile broadband (eMBB) and ultra-reliable, low-latency communications (URLLC). The results are high-speed data rates and very low latency wireless communications.

These specifications introduce new challenges for device and component designers. Measurements become more critical, along with the need to validate protocols for the many different test cases, and verify RF performance to deliver the expected quality of service (QoS). Massive MIMO and beam steering introduce challenges in beam management. The use of mmWave frequencies pose challenges in signal quality, and the requirement of OTA testing makes validation even more difficult.

Embracing 5G

Emerging technologies such as cloud computing, artificial intelligence (AI) and machine learning, augmented and virtual reality, the IoT, and billions of connected devices push the boundaries of the wireless communications system like never before. 5G technology promises faster, more reliable, and near-instant connections that will universally connect people. Imagine live events and video games experienced in real-time. Phone and video calls feel close and intimate, and smart devices paired with AI create a customized and personalized environment for everyone.

5G NR will work alongside 4G and even utilize the 4G core network for both data and control planes in non-standalone mode (NSA). 5G, 4G, and Wi-Fi need to coexist on the same carriers and utilize unlicensed bands to increase capacity below 6 GHz. 5G NR Release 15 sets the foundation to enable flexibility to accommodate future releases of 5G communications. The physical layer is the first step in the adoption of 5G NR. It defines the structure that makes up the radio signal and makes the signal communication through the air interface possible.

New Challenges Ahead

The challenges associated with implementing device designs in the physical layer include:

- Flexible time and frequency intervals enable low latency but result in complex channel coding, signal-quality challenges, and numerous test cases.
- Bandwidth parts yield more efficient use of spectrum, but introduce new coexistence issues.
- Massive MIMO and mmWave beam steering enable higher throughput and capacity gains, but introduce new challenges in beam management.
- Use of mmWave frequencies allows for greater channel bandwidths, but introduces new challenges in signal quality and the need for OTA tests.

5G NR Specifications

NR Release 15 specifies a new air interface to enable higher data throughput and low latency use cases. The addition of the mmWave spectrum up to 52.6 GHz is the key to enabling higher data throughput. At these higher frequencies, there is a more contiguous spectrum available to send more data through the channel. Release 15 specifies a maximum carrier bandwidth up to 400 MHz and up to 16 component carriers, that when aggregated, add up to 800 MHz of bandwidth. Also, flexibility and scalability in the slot structure help support the many new and diverse use cases expected in 5G. Figure 2.1 maps out the contributions of different specifications to deliver a flexible and scalable physical layer and shows the distinct advantages of 5G NR.

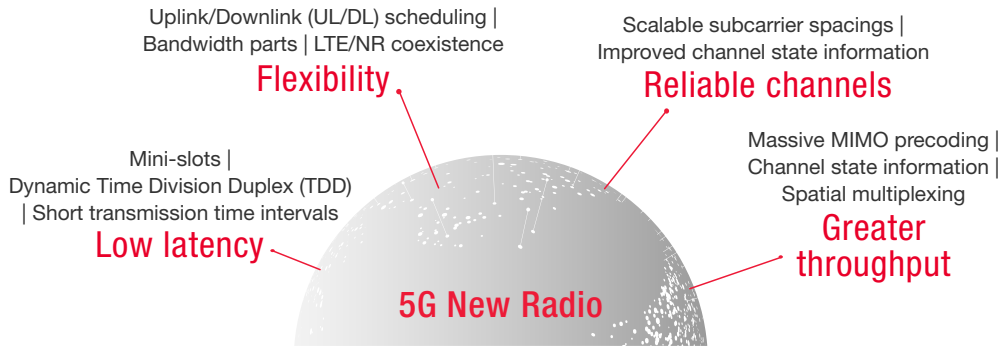

Figure 2.1. 5G NR Release 15 technologies and their benefits

Flexible waveform and numerology

In 5G NR, cyclic prefix orthogonal frequency division multiplex (CP-OFDM) is defined as the modulation format (or waveform) in the downlink (DL) and uplink (UL). CP-OFDM use is well-known for DL transmissions but is new for UL transmissions in mobile. Having the same waveform in both UL and DL enables easier communication for device-to-device communication in future releases. Discrete Fourier transform spread OFDM (DFT-s-OFDM) is an optional waveform in the UL. DFT-s-OFDM uses a single transmission, which is helpful in power-limited scenarios.

Unlike 4G, NR allows for scalable OFDM numerology (μ) where the subcarrier spacings are no longer fixed to 15 kHz. With NR, subcarrier spacing is governed by $2^\mu \times 15$ kHz subcarrier spacings. Lower frequency bands use 15, 30, and 60 kHz subcarrier spacings, and higher frequency bands use 60, 120, and 240 kHz subcarrier spacings. Scalable numerology enables scalable slot duration to optimize for different service levels in throughput, latency, or reliability. Larger subcarrier spacing at the higher frequencies also helps with the robustness of the waveform since integrated phase noise is an issue in mmWave designs. Figure 2.2 shows how the different subcarrier spacings and the associated transmission time interval (TTI) with each scales the size of the slot.

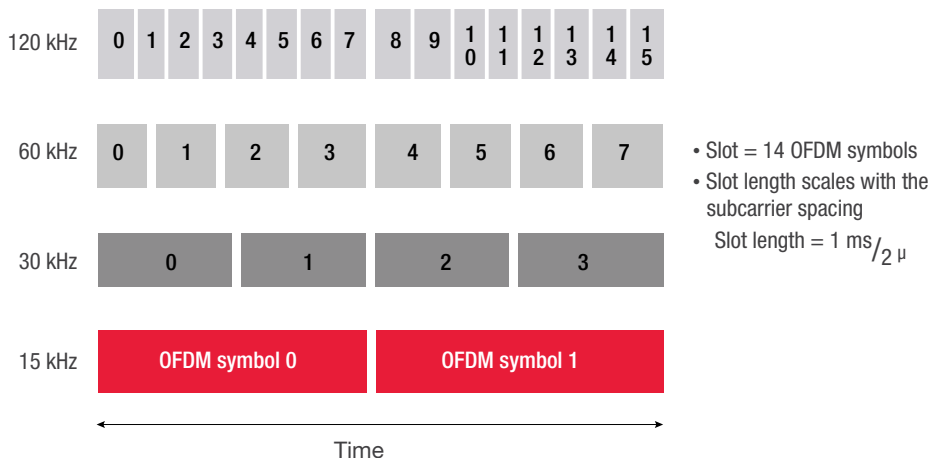

Figure 2.2. Relationship between subcarrier spacings and time durations

In an OFDM system, using CP mitigates the effects of channel delay spread and inter-symbol interference (ISI). CP provides a buffer to protect the OFDM signal from ISI by repeating the end of the symbol at the start of the same symbol. While this reduces the achievable data rate, it eliminates the ISI up to the length of the CP. In 5G NR, as subcarrier space changes, the cyclic prefix length also scales accordingly, making it possible to adapt the CP length to the channel conditions.

Low latency mini-slots

URLLC is one of three primary 5G use cases and is achieved partially through mini-slots. In long term evolution (LTE), transmissions adhered to the standard slot boundaries, but they are not optimized for minimal latency. A standard slot has 14 OFDM symbols shown in Figure 2.3. As the subcarrier spacing increases, the slot duration decreases. A mini-slot is shorter in duration than a standard slot and located anywhere within the slot. A mini-slot is 2, 4, or 7 OFDM symbols long. Mini-slots provide low latency payloads with an immediate start time without needing to wait for the start of a slot boundary.

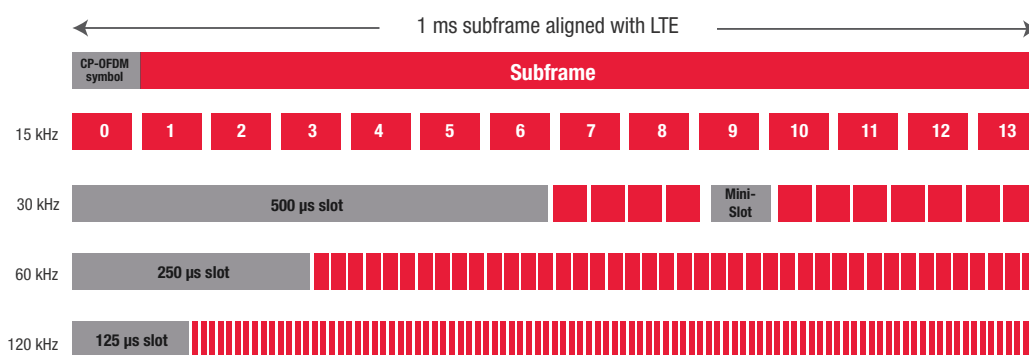

Figure 2.3. Slots and mini-slots within a subframe and their associated slot duration time

Flexible slot structures

NR subframe structure also allows for dynamic assignments of the OFDM symbol link direction and control within the same subframe, as shown in Figure 2.4. By using this dynamic-time division duplex (TDD) mechanism, the network dynamically balances UL and DL traffic requirements and includes control and acknowledgment all in the same subframe. The slot format indicator (SFI) denotes whether a given OFDM symbol in a slot is used for the UL, DL, or is flexible.

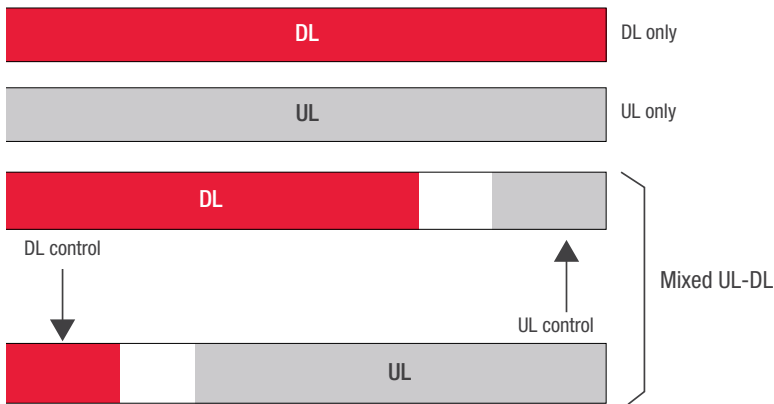

Figure 2.4. Slot structure is mixed to improve traffic dynamically

Flexible bandwidth parts

In LTE, carriers are narrower in bandwidth – up to 20 MHz maximum – which, when aggregated together, create a wider channel bandwidth up to 100 MHz. In 5G NR, the maximum carrier bandwidth is up to 100 MHz in FR1 (up to 24 GHz), or up to 400 MHz in FR2 (up to 52.6 GHz). New in 5G NR are bandwidth parts where the carrier is subdivided for different purposes. Each bandwidth part has its own numerology and is signaled independently. One carrier can have mixed numerologies to support a mixed level of services, like power saving or multiplexing of numerologies, and services in unlicensed bands. However, only one bandwidth part in the UL and one in the DL are active at a given time. Bandwidth parts will support legacy 4G devices with new 5G devices on the same carrier. With 4G, 5G, and potentially Wi-Fi multiplexing services, it is necessary to minimize both in- and out-of-band emissions. Figure 2.5 shows some examples of how bandwidth parts support different services in a given carrier.

Bandwidth parts

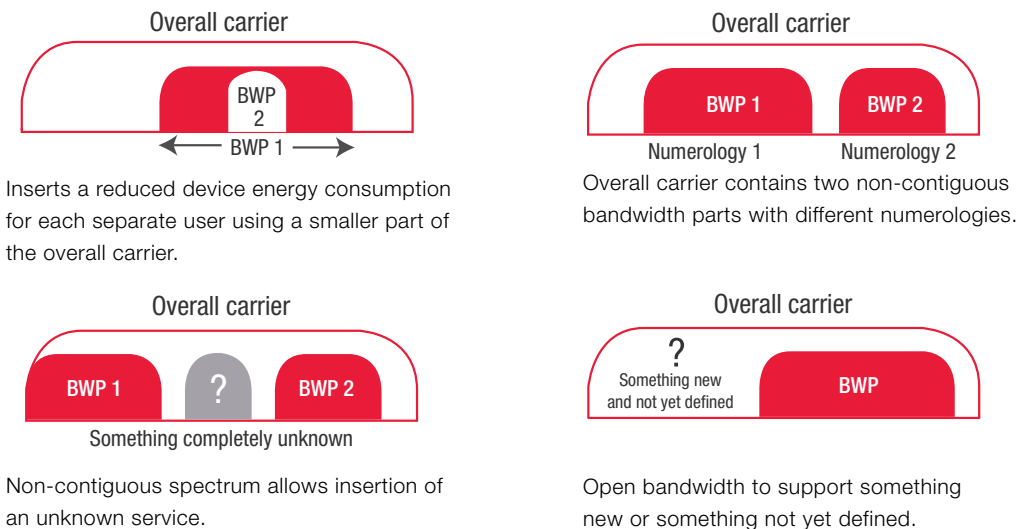

Figure 2.5. Bandwidth parts support multiplexing of different services on the same carrier

Greater throughput through massive MIMO and beam steering

Just like previous generation upgrades, throughput is key to making 5G communications successful. 5G boosts throughput in multiple ways:

- Wider overall channel bandwidths enable sending more data through the air interface
- Spatial multiplexing sends multiple independent streams of data through multiple antennas at a given time and frequency, and uses enhanced channel feedback

Enhanced channel feedback improves throughput since the signal is optimized for transmission with advanced channel coding to deliver the higher throughput.

Massive MIMO and beam steering technologies improve throughput. NR Release 15 specifies frequency use up to 52.6 GHz with up to 400 MHz bandwidth per carrier, and aggregation of multiple carriers for up to 800 MHz channel bandwidth.

Operating at mmWave frequencies, however, introduces new challenges in path loss, blockage, and signal propagation. Beam steering is a key technology to overcome these issues. NR specifies new initial access procedures to ensure alignment of the directional transmissions used in beam steering. As shown in Figure 2.6, new initial access techniques use beam sweeping to have the base station transmit multiple beams and then identify the strongest beam and establish a communication link. Validating initial access, beam management, and throughput achieved through the wireless link are key factors for successful beam steering implementation in 5G.

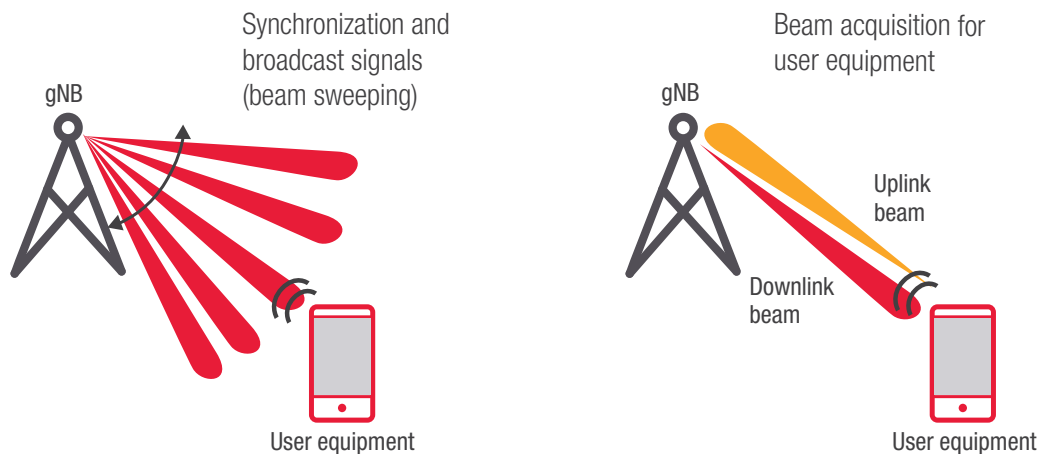

Figure 2.6. Beam sweeping and initial access

Channel state information to improve beamforming reliability

Channel state information (CSI) will help with 5G NR beamforming reliability. 5G NR specifies a new beam management framework for CSI acquisition to reduce coupling between CSI measurements and reporting to control different beams dynamically. CSI uses channel estimation to intelligently change the precoding and adapt the beam to a specific user. The better and more precise this CSI information, the better the link adaptation.

A 5G NR waveform

It is important to understand the frequency-, time-, and modulation-domain analysis of the 5G NR waveforms. Software and hardware that create and analyze a 5G waveform for the many different use cases at sub-6 GHz and in the new mmWave frequencies with greater bandwidths enables an essential diagnostic capability. New capabilities in NR specifications, including flexible numerologies with different subcarrier spacing, dynamic TDD, and bandwidth parts, add to the complexity of creating and analyzing the waveform. Figure 2.7 shows two different NR waveforms created using Keysight's 5G PathWave Signal Generation (Signal Studio) software and signal generators. Keysight's PathWave 89600 VSA NR software performs the associated analysis.

An analysis of a 400 MHz bandwidth, 256 QAM NR signal at 39 GHz.

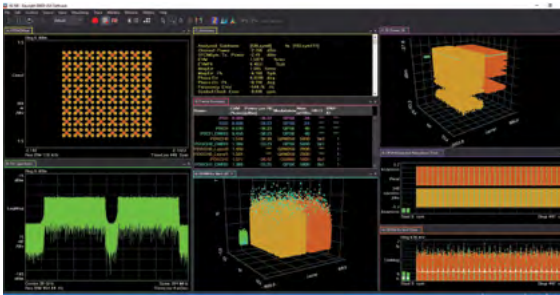

A simultaneous analysis of a 5G NR and 4G LTE carriers in adjacent bands.



Figure 2.7. Using 5G signal generators, signal analyzers, and PathWave VSA software to analyze 4G and 5G waveforms

Chapter 3

mmWave Spectrum

The eMBB use case targets peak data rates as high as 20 gigabits per second (Gbps) in the DL and 10 Gbps in the UL to support new applications such as high-speed streaming of 4K or 8K ultra high-definition (UHD) movies. While there are different ways to improve data rates, spectrum is at the core of enabling the higher mobile broadband data rates. 5G NR specifies new frequency bands below 6 GHz and extends into mmWave frequencies, where more contiguous bandwidth is available for sending lots of data.

While consumers will greatly appreciate the increased bandwidth, it introduces new challenges to meet link quality requirements at mmWave frequencies. Impairments are not an issue at sub-6 GHz but become more problematic at mmWave frequencies. Extra consideration is needed to determine test approaches that provide the precision required to evaluate 5G components and devices accurately.



A Look at 5G Spectrum

Spectrum harmonization across regions is limited. It is challenging for designers to deliver the full range of capabilities and coverage for consumers around the world. 5G NR specifies frequency up to 52.6 GHz, and even the initial new operating bands open up almost 10 GHz of new spectrum.

- Frequency Range 1 (FR1): 410 MHz to 7.125 GHz adds 1.5 GHz of new spectrum in frequency bands: 3.3–4.2 GHz, 3.3–3.8 GHz, 4.4–5 GHz, and 5.925–7.125 GHz.
- Frequency Range 2 (FR2): 24.25 to 52.6 GHz initially added 8.25 GHz of new spectrum in frequency bands: 26.5–29.5 GHz, 24.25–27.5 GHz, and 37–40 GHz.

Studies and trials in key regions and operating bands in new FR1 territory (>2.5 GHz) and FR2 have surfaced in initial launches, as shown in Table 3.1.

- Below 1 GHz, there are multiple bands of interest in 600, 700, and 800 MHz to support the IoT and other mobile services.
- 1–6 GHz enables increased coverage and capacity. A primary target in China, Europe, Korea, and Japan is the 3.3–3.8 GHz range. China and Japan are also considering the 4.4–4.9 GHz range.
- Above 6 GHz will primarily support the need for ultra-high broadband use cases. Initial mmWave targets are 28 GHz and 39 GHz in Japan and the US. While 5G NR Release 15 specifies frequency range up to 52.6 GHz, studies are underway for future releases to include from 52.6 up to 110 GHz.

Spectrum	0.6 GHz	2.5 GHz	3.4–3.7 GHz			4.4–4.9 GHz	28 GHz		39 GHz	47 GHz
Geography	USA	USA	Europe	China	Japan South Korea	Japan	USA	Japan	USA	USA
Commercial Services	2019	Late 2019	2019	2020	2020	Mid-2020	2018	2020	2018	2021

Table 3.1. 5G spectrum commercial trials and rollout from sub-6 GHz to mmWave frequencies

Similar to LTE, multiple component carrier aggregation provides larger bandwidths, up to a maximum bandwidth of 800 MHz at FR2. For the initial 5G NR release, individual countries will decide on the amount of spectrum deployed. Frequency, bandwidth, and waveforms will continue to evolve with future 5G NR releases to support new use cases.

Band Numbers	Range (MHz)	Duplex Mode
N257	26,500—29,500	TDD
N258	24,250—27,500	TDD
N260	37,000—40,000	TDD
N261	27,500—28,350	TDD

Table 3.2. 5G NR initial Release 15 frequency and waveform specification
Source: 3GPP TS 38.101-2 v15.2

Sub-Carrier Spacing	50 MHz $N_{RB}/SC/GB$	100 MHz $N_{RB}/SC/GB$	200 MHz $N_{RB}/SC/GB$	400 MHz $N_{RB}/SC/GB$
60 kHz	66/792/1210 kHz	132/1584/2450 kHz	264/3168/4930 kHz	N/A
120 kHz	32/384/1900 kHz	66/792/2420 kHz	132/1584/4900 kHz	264/3168/9860 kHz

Table 3.3. Maximum Tx Bandwidth
Source: 3GPP TS 38.101-2 v15.2

FR1 introduces new challenges for designs in the new bands above 3 GHz due to the complexity of the test cases, coexistence issues, and validating massive MIMO designs over the air. FR1 is an evolution of existing LTE-Advanced (LTE-A) capabilities and the implementation of mmWave designs will introduce more significant challenges.

A First Application

Fixed wireless access (FWA) was the first mmWave introduction at the end of 2018. Initial 5G fixed wireless access implementations operate in NSA, utilizing the 4G evolved packet core (EPC) and eNodeB (eNB) as an anchor and control plane. A significant change will happen when mmWave implementations go mobile. There will be new challenges establishing and maintaining the communication link when the device is moving across a parking lot, down a highway, or even on a high-speed train. Trials have been underway for some time to ensure the viability of different mmWave mobile use cases. Refining the channel models for the different use cases will require components and devices to have the performance necessary to operate in mmWave frequency bands.

mmWave Signal Quality Challenges

Many factors impact signal quality, including baseband signal processing, modulation, filtering, and up conversion. With wider channel bandwidths expected at mmWave frequencies, common signal impairments impact baseband and RF designs. These impairments become more problematic at higher frequencies or with wider bandwidths. Inherent in OFDM systems, orthogonal properties prevent interferences between overlapping carriers. However, impairments such as in-phase and quadrature (IQ) impairments, phase noise, linear compression (AM to AM) and nonlinear compression (AM to PM), and frequency error cause distortion in the modulated signal. Phase noise is one of the most challenging factors in mmWave OFDM systems. Too much phase noise in designs results in each subcarrier interfering with other subcarriers, leading to impaired demodulation performance.

Such issues impact the performance of your designs and are difficult to resolve. Device designs need to overcome the physical challenges in wide bandwidth and mmWave signals. Test solutions require better performance than the device under test (DUT) to accurately measure and characterize the signal quality without introducing new issues.

Characterizing signal quality

Evaluating a signal's modulation properties provides one of the most useful indicators of signal quality. Viewing the IQ constellation helps to determine and troubleshoot distortion errors. Another key indicator of a signal's modulation quality is a numeric EVM measurement that provides an overall indication of waveform distortion.

5G NR specifies CP-OFDM modulation, a multi-carrier modulation scheme. An EVM measurement reflects any variation in a circuit's phase, amplitude, or noise seen in wideband signals. EVM is the normalized ratio of the difference between two vectors: IQ measured signal and IQ reference (IQ reference is a calculated ratio value) as shown in Figure 3.1. It is typically measured in dB or as a percentage.

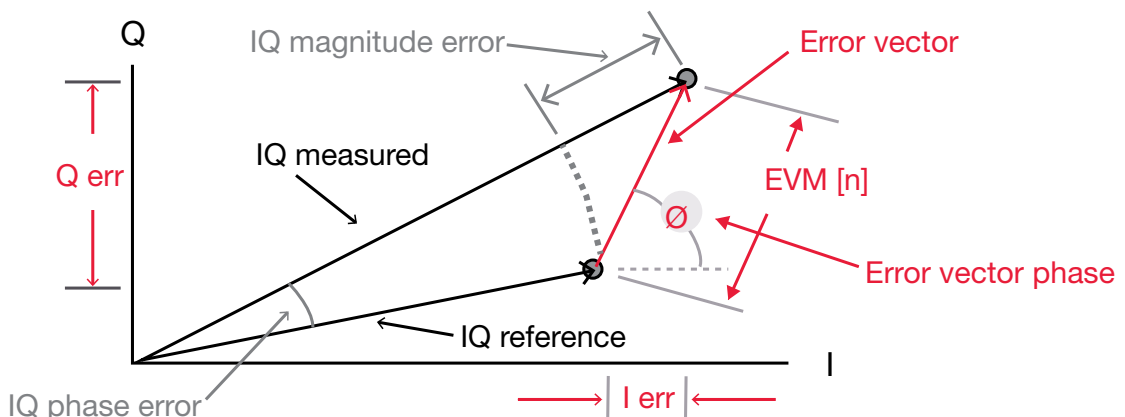

Figure 3.1. Understanding the EVM calculation

With the expected use of higher-order modulation schemes in 5G (up to 256 QAM initially, and up to 1024 QAM in the future), components and devices require a better EVM result as the modulation density increases. For example, Table 3.3 shows how 3GPP EVM requirements for user equipment (UE) get tighter as the modulation density increases.

Modulation scheme for physical downlink shared channel (PDSCH)	Required EVM
QPSK	17.5%
16 QAM	12.5%
64 QAM	8%
256 QAM	3.5%

Table 3.4. 3GPP TS 38.101-1 EVM requirements for different 5G modulation schemes

Spectrum measurements are also necessary to validate a signal's RF performance. 5G UE spectrum measurements for transmitting products include transmitted power, occupied bandwidth (OBW), adjacent channel power ratio (ACPR), spectrum emissions mask (SEM), and spurious emissions.

A test solution needs to have enough performance to evaluate the constellation diagram and measure the EVM required by 5G components and devices. Flexibility to make spectrum measurements and scale to higher frequencies and bandwidths is required as the 5G standards evolve.

Defining a measurement solution

To achieve high-quality measurements of high bandwidth devices at mmWave frequencies requires a test solution with EVM performance that is better than the product or system under test. Typical guidelines include:

- For component test: 10 dB better than the system as a whole
- For system test: 3 dB better than the source from the radio standard

When measuring a transmitter, receiver, transceiver, or other components in a wireless device, a test solution typically consists of a stimulus and DUT, a DUT and analyzer, or a stimulus, DUT, and analyzer, depending on the DUT. Measurements in baseband and sub-6 GHz can typically be conducted using cables. However, measurements at centimeter-wave or mmWave frequencies typically require an OTA measurement due to the high level of integration expected in the antennas and radio frequency integrated circuits (RFICs). These highly integrated packages typically have no connector test points for conducted test, mandating the need for OTA test methods.

Figure 3.2 shows the 5G R&D Test Bed setup. It has the performance needed to evaluate 5G components and devices for impairments at mmWave frequencies. A vector signal generator produces a digitally modulated 5G NR signal into the DUT. A vector signal analyzer captures the RF signal properties out of the DUT and digitizes the modulated signal for analysis. This test solution offers flexible

configurations to address the many combinations of frequency, bandwidth, and fidelity required for testing 5G components and devices.

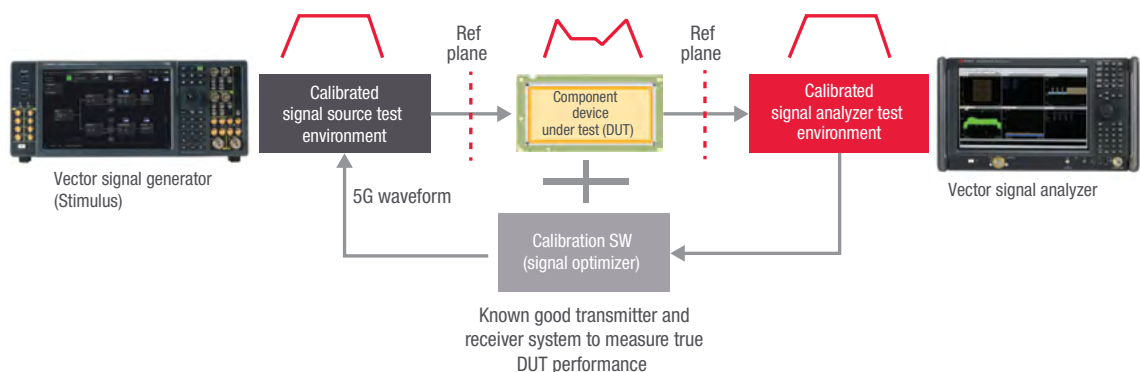

Figure 3.2. 5G R&D Test Bed with 5G NR ready hardware and software, including signal optimizer calibration

The test setup itself can introduce other sources of error in a measurement system. When considering a test setup at higher frequencies with wider bandwidths, items such as test fixtures, cables, adaptors, couplers, filters, preamplifiers, splitters, and switching between the DUT and measurement equipment have a greater impact than in sub-6 GHz measurement systems. Calibrating the measurement system to the reference plane at the location of the DUT is essential to achieve the highest measurement accuracy. The goal is to see the true characteristics of the DUT without seeing the impacts of the test setup. The measurement system needs to perform better than the DUT design goals. Measurements at the DUT plane are more accurate and repeatable. A proper system-level calibration eliminates uncertainties due to test fixtures in frequency and phase and is valuable for very wide bandwidth signals. The 5G R&D Test Bed solution includes the signal optimizer software that moves the calibration plane from the test equipment to the DUT reference plane, as shown in Figure 3.2.



Connectors, cables, and adapters

In addition to calibration, proper use of cables, connectors, and adapters improves the accuracy of your test setup. The materials, structures, and geometries of these components are designed for specific operating frequency ranges. Avoid compromising the performance of an expensive test system with poor-quality or inappropriate cabling and accessories. Since most mmWave spectrum analyzers are used in an environment that also includes work at lower frequencies, it can be tempting to use connectors designed for these lower frequencies. However, smaller wavelengths demand smaller dimensions in both the cables and the connectors. For mmWave measurements, do not use common subminiature version A (SMA) or precision 3.5 mm accessories.



For mixed-frequency environments, standardize on 2.4 mm or 2.92 mm accessories. Although they have slightly more insertion loss than SMA and 3.5 mm (primarily above 30 GHz), 2.4 mm and 2.92 mm accessories can cover all lower frequencies and offer superior repeatability.



A 5G NR mmWave measurement

Proper selection of test equipment, connectors, adapters, and system-level calibration enables high-performance measurements to evaluate the true performance of a 5G component or device. Figure 3.3 shows a calibrated measurement of a 5G antenna using Keysight's 5G R&D Test Bed solution to characterize 5G NR devices from RF to mmWave frequencies with precision and modulation bandwidths up to 2 GHz. With 5G NR compliant software, waveforms are easily created and analyzed with 5G numerology, uplink, and downlink to test 5G NR and LTE integration and coexistence.

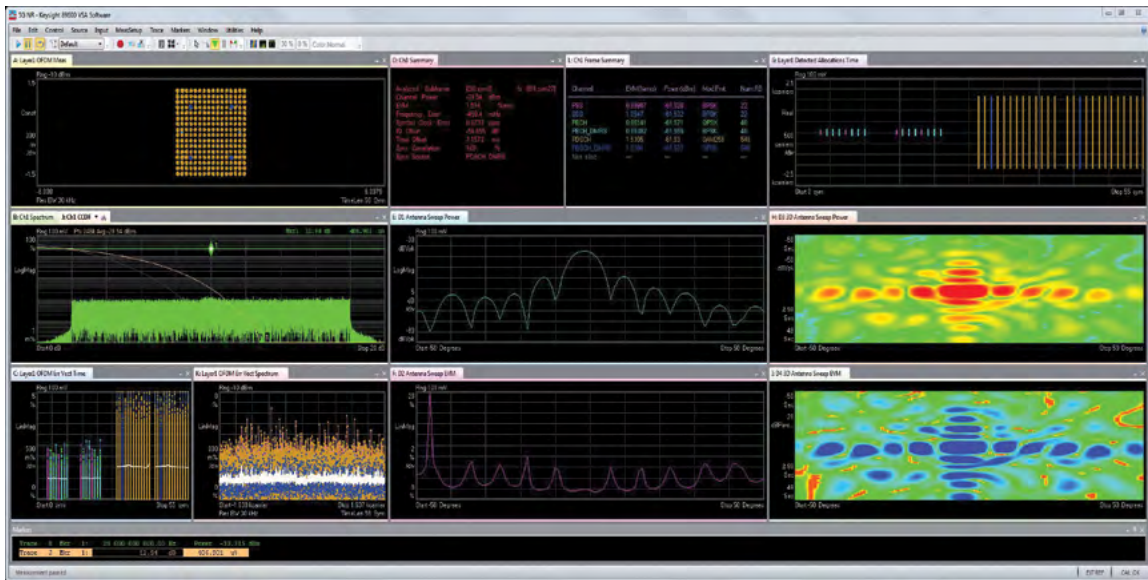

Figure 3.3. Analysis of a 5G NR 256 QAM signal with antenna pattern



MIMO introduces 3 key design challenges:

1. 3D antenna beam pattern verification
2. Validation of mmWave link integrity
3. Device performance optimization under real-world conditions

Chapter 4 Massive MIMO and Beamforming

MIMO, beam steering, and beamforming are the most talked-about technologies in 5G. They are essential to delivering the 100x data rates and the 1000x capacity goals specified in the International Mobile Telecommunications-2020 (IMT-2020) vision. IMT-2020 defines the requirements issued by the International Telecommunication Union (ITU) Radiocommunication Sector in 2015 for 5G networks, devices, and services.

According to the Ericsson Mobility Report¹ (June 2019), mobile data traffic grew 82% from Q1 2018 to Q1 2019 and is expected to rise at a compound annual growth rate of 30% through 2024. Projections indicate that there will be 8.8 billion mobile subscriptions by 2024, including 1.9 billion for 5G enhanced mobile broadband.

¹ ericsson.com/49d1d9/assets/local/mobility-report/documents/2019/ericsson-mobility-report-june-2019.pdf

MIMO is one important approach to improve the capacity and efficiency of a network to meet these demands. Multi-antenna technologies must support multiple frequency bands — from sub-6 GHz to mmWave frequencies across many scenarios, including massive IoT connections and extreme data throughput. Implementing MIMO on 5G devices brings several new design challenges, including 3D antenna beam pattern verification, mmWave link integrity, and optimization of device performance under real-world conditions.

MIMO Technology Basics

Understanding MIMO challenges requires a basic knowledge of the techniques used to deliver high quality, robust signals to and from the 5G device. There are many different techniques for implementing MIMO, and each one offers distinct benefits and compromises.

Spatial diversity is a technique commonly used to improve reliability in many forms of RF communication. Spatial diversity consists of sending multiple copies of the same signal via multiple antennas. With this technique, the chances of properly receiving the signal are higher, improving reliability.

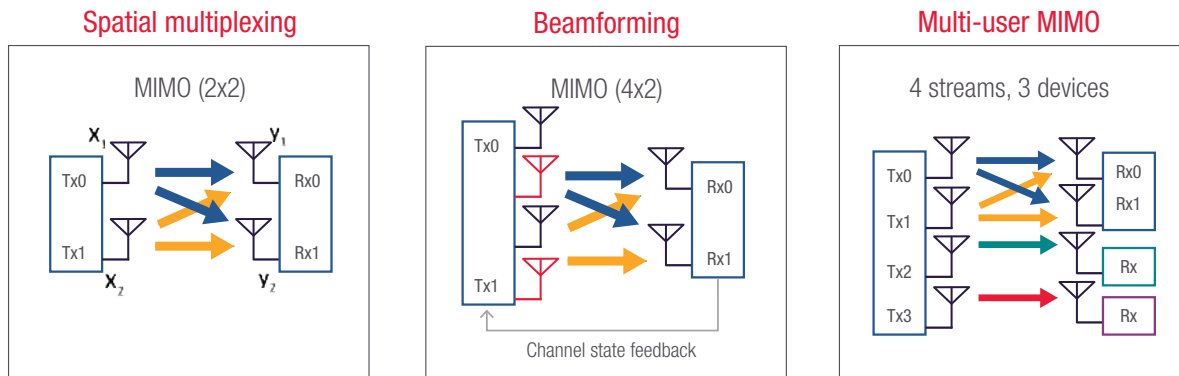

Figure 4.1. Spatial multiplexing MIMO configurations

Spatial multiplexing, as shown in Figure 4.1, is a different multiple-antenna technique that feeds independent data into each antenna, with all antennas transmitting at the same frequency. Spatial multiplexing creates multiple channels with independent streams, which increases the overall data capacity.

Beam steering and beamforming are additional techniques that use multiple antennas to create directional transmissions, increasing gain in exchange for a beam that must accurately point at the receiving antenna. Beamforming is more complex than beam steering, incorporating channel feedback to manipulate the beam shape and direction in real-time. Spatial multiplexing with beamforming increases signal robustness with the added advantage of improved throughput. Multi-user MIMO is a technique that uses multiple beams directed at different devices to achieve even greater spectral efficiency.

MIMO and Beamforming Challenges and Solutions

MIMO and beamforming at mmWave frequencies introduce many new challenges for device designers. 5G NR standards provide the physical-layer frame structure, new reference signal, and new transmission modes to support 5G eMBB data rates. Designers must understand the 3D beam patterns and ensure the beams can connect to the base station and deliver the desired performance, reliability, and user experience. The following techniques are essential to implement your 5G device design successfully:

- 3D antenna beam pattern verification
- mmWave link integrity validation
- Device performance optimization under real-world conditions

Beam pattern verification

Beam performance validation requires measurements of 3D antenna beam patterns to verify the right antenna gain, sidelobes, and null depth for the full range of 5G frequencies and bandwidths. The location of the sidelobes and nulls is important to tune the antenna and maximize the radiated efficiency of the signal.

While design verification of prototypes is crucial, building mmWave prototypes is costly. Modeling an antenna in a simulated system with channel models and base station links provides insights early in the design cycle, reducing prototype and re-work costs. The simulation data becomes an important part of the design process and helps to troubleshoot throughout the development workflow.

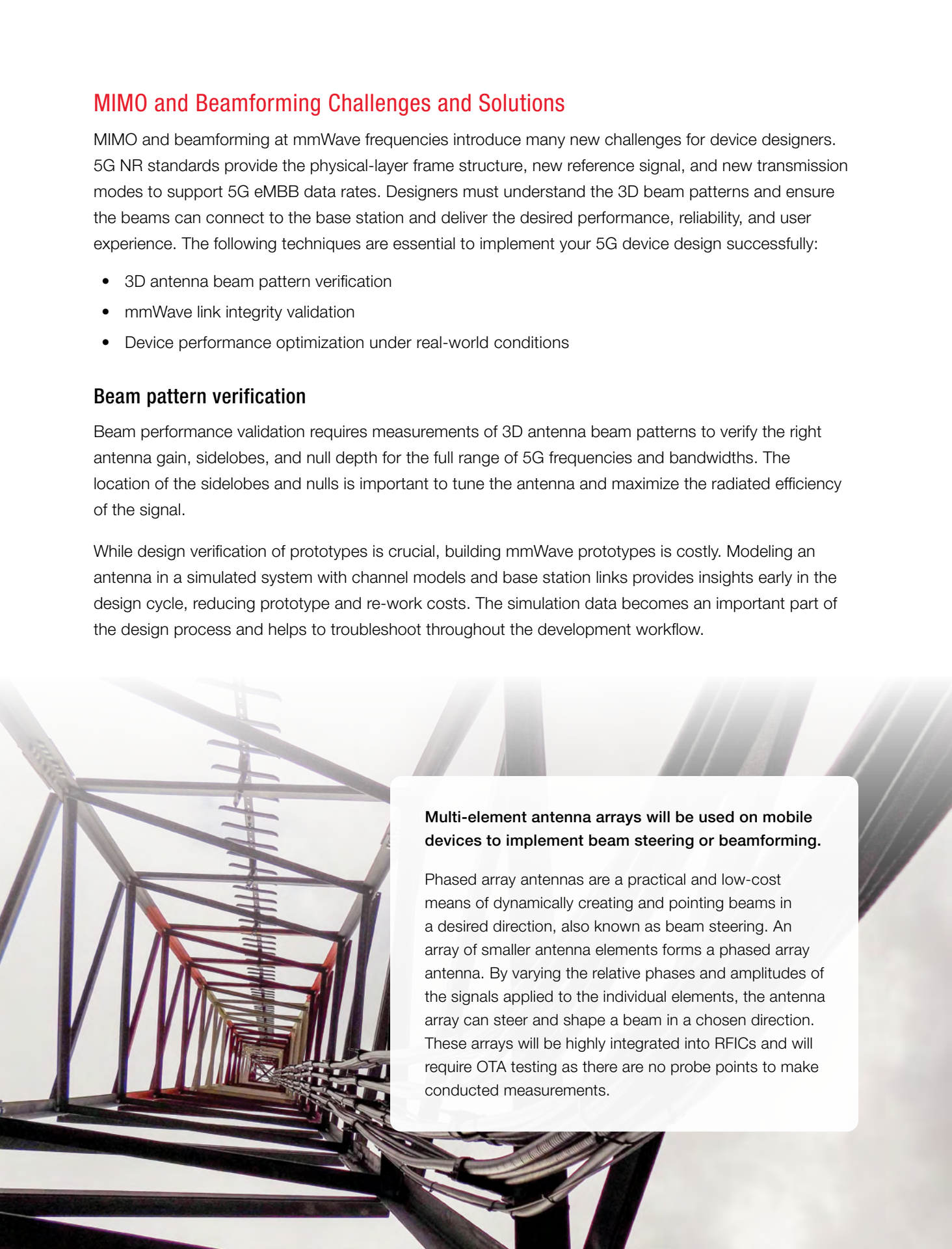

Multi-element antenna arrays will be used on mobile devices to implement beam steering or beamforming.

Phased array antennas are a practical and low-cost means of dynamically creating and pointing beams in a desired direction, also known as beam steering. An array of smaller antenna elements forms a phased array antenna. By varying the relative phases and amplitudes of the signals applied to the individual elements, the antenna array can steer and shape a beam in a chosen direction. These arrays will be highly integrated into RFICs and will require OTA testing as there are no probe points to make conducted measurements.

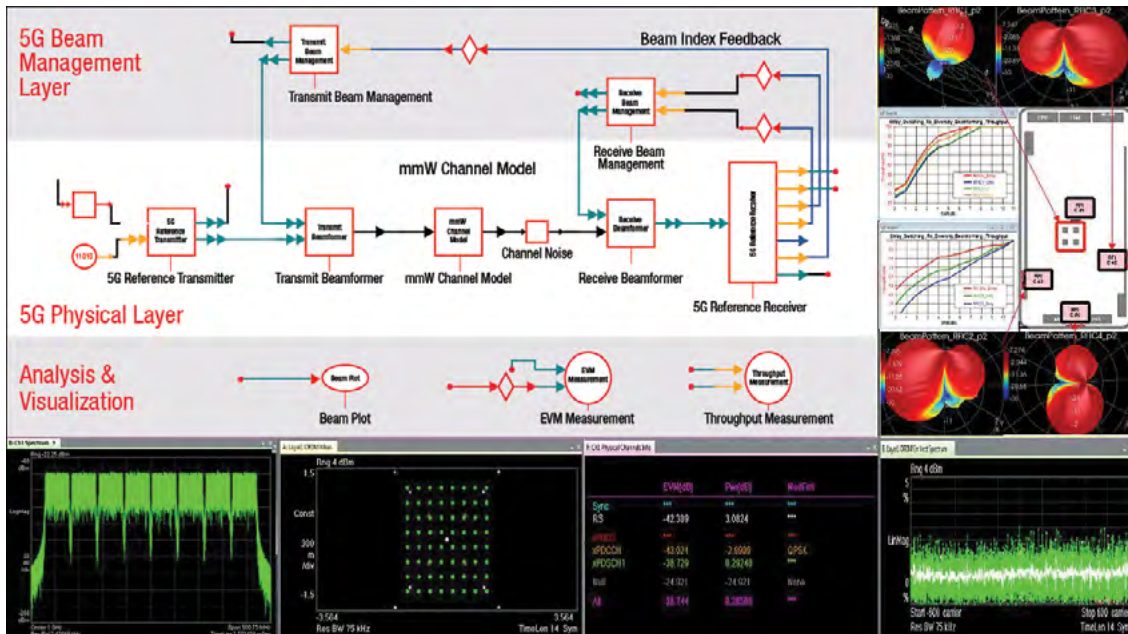

Figure 4.2. Electronic system-level tools such as PathWave System Design (SystemVue) help designers quickly integrate and validate their designs before moving to hardware

As mentioned above, once a design moves into hardware, designers must validate that the device produces the correct beam width, null depth, and gain over the required range and meets power output limits. In hardware, this requires OTA test methods.

mmWave link integrity

LTE systems use antennas covering large angular areas to cast a wide net for potential users. 5G will use narrow beams to overcome mmWave signal propagation issues, but this makes it much more difficult for the UE to find the beams from the base station. Maintaining a quality link is also an issue, especially when the device is in motion. 5G NR Release 15 specifies new procedures for initial access and attach when establishing the wireless link connection. Since neither the device nor the base station knows the other's location, the base station uses beam sweeping to transmit channel information in sync blocks across the spectrum as shown in Figure 4.3. The UE determines the strongest match and transmits back to the base station. Once the base station knows the direction of the UE, it establishes a communication link.

Beam acquisition and tracking, beam refinement, beam feedback, and beam switching procedures exist. It takes longer to establish connections when using mixed numerologies. Designers need to implement, validate, and optimize all these functions, or the user will experience dropped calls or poor performance.

Testing the protocol early in the development cycle ensures the device can establish and maintain a call. A network emulator with a built-in protocol state machine emulates network signals and tests the resulting device signals to verify and optimize initial access and beam management.

Initial access and beam management

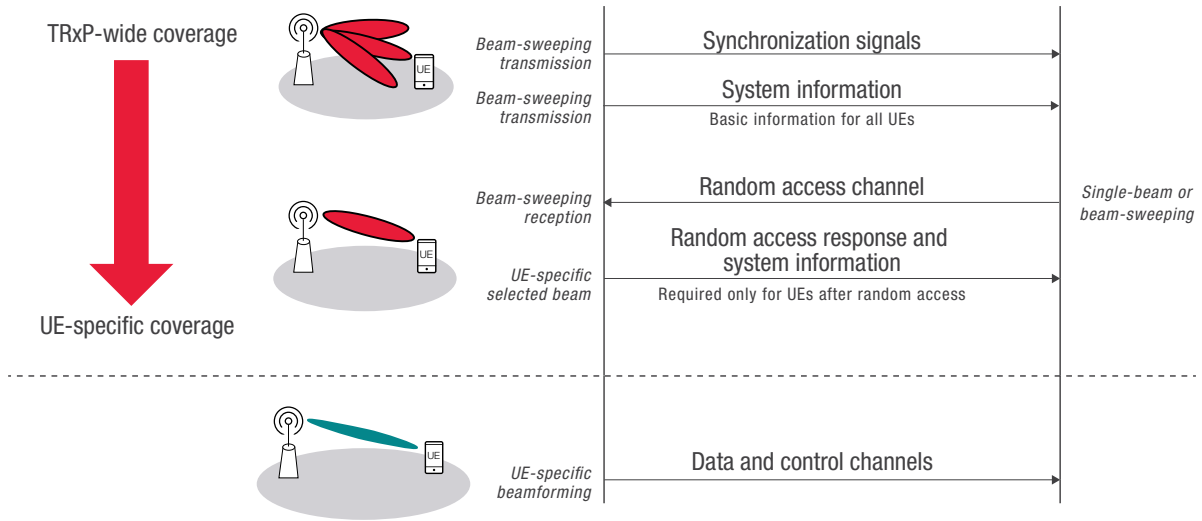

Figure 4.3. 5G initial access and beam management

Device performance optimization under real-world conditions

Key performance indicators for the wireless communications system include throughput and latency. If the latency — or delay — is too great, then the end-user experience suffers. The different layers of the protocol stack need to work together to deliver the latency and throughput targets of the 5G system. It is important to understand how the device will perform, not only when acquiring a beam, but also when performing handovers, fallback to 4G, and other beam management functions.

One of the most efficient methods for testing end-to-end beam throughput is by using a network emulator to send protocol commands to the UE and measuring the UE's response. A network emulator provides the scripts to configure a 5G cell connection, change power levels for synchronization and reference signals, and set beamforming parameters and resource blocks for transmit and receive control.

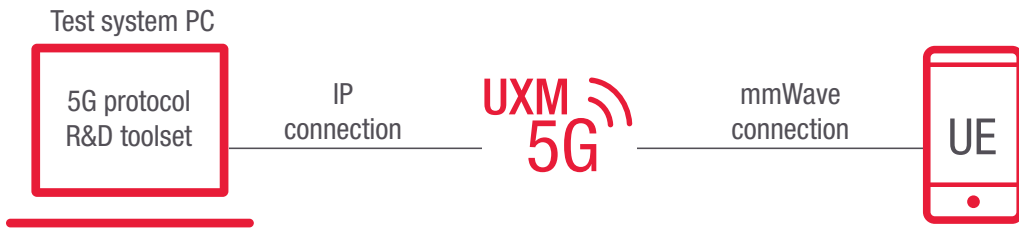

Figure 4.4. Test setup with a Keysight network emulator (UXM)

Most component and device testing requires a controlled environment. However, these devices need to operate in environments that have signal propagation issues, including excessive path loss, multi-path fading, and delay spread. These real-world impairments impact device performance and require evaluation. Adding a channel emulator to the test setup enables the characterization of end-to-end full stack data throughput while emulating a variety of real-world radio conditions.

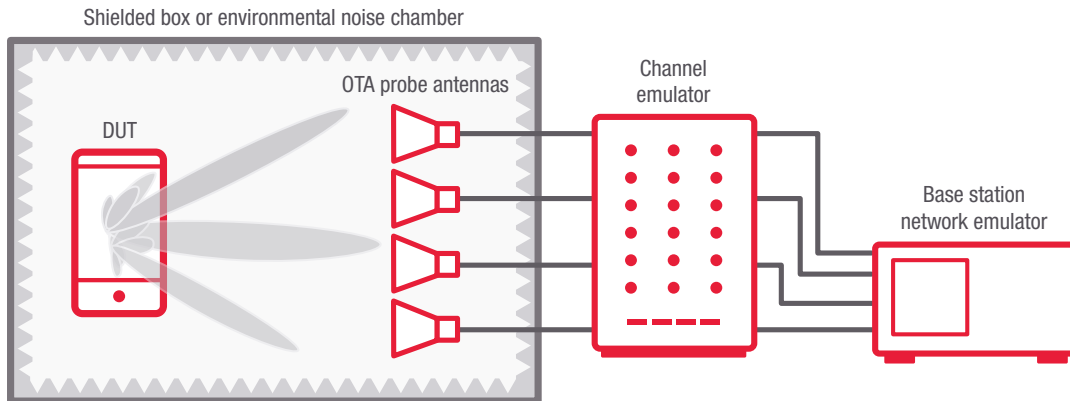

Figure 4.5. A channel emulator, such as the Keysight PROPSIM F64, lets you evaluate under real-world conditions



You must address these three challenges to successfully test 5G mmWave:

1. Excess path loss at mmWave frequencies
2. Evolving mmWave OTA test methods
3. Measuring device performance under real-world channel conditions

Chapter 5 **Over-The-Air Testing**

OTA testing is one of the most challenging aspects of 5G device development. Designers need to address many aspects of 5G, including the new 5G NR standard, flexible numerology, mmWave design considerations, MIMO, and beamforming challenges. The combination of these technologies introduces substantial new test challenges that require OTA testing for validation.

To meet downlink peak data rates of up to 20 Gbps promised by eMBB use cases, MIMO, beam steering, and carrier aggregation are critical. OTA testing is needed to test highly integrated modems and validate designs under the unique mmWave channel conditions. In the OTA test environment, it is necessary to visualize, characterize, and validate 5G device beam patterns and performance in a variety of real-world scenarios.

However, 3GPP-approved OTA tests are constantly evolving. Understanding the underlying challenges and proposed OTA test methods is essential to develop 5G NR devices successfully.

New Test Methodologies Required for mmWave

mmWave frequencies are important because they offer a more contiguous spectrum and wider bandwidth radio channels. mmWave signals are also subject to signal propagation issues that were not a problem at sub-6 GHz. These include increased path loss, delay spread, or even blockage due to chassis or human interference. All of which makes it more difficult to establish and maintain a wireless communication link. 5G radio systems use multi-antenna spatial diversity and beam steering techniques on both base stations and mobile devices to overcome these challenges. These technologies improve signal robustness by reliably directing narrow beams in specific directions.

The mmWave antenna arrays are quite small; 24 GHz full-wave spacing is just 12.5 mm. 5G smartphone manufacturers need real estate for GPS, Wi-Fi, Bluetooth, and antennas that support multiple cellular frequencies. In addition to the real estate constraints, mmWave antenna arrays require physical bonding to the amplifier semiconductors for transmit (Tx) and receive (Rx) of the radio. These integrated designs are impractical to probe, and testing mmWave signals becomes impossible with cabled tests. Figure 5.1 gives some examples of handset antenna arrays.

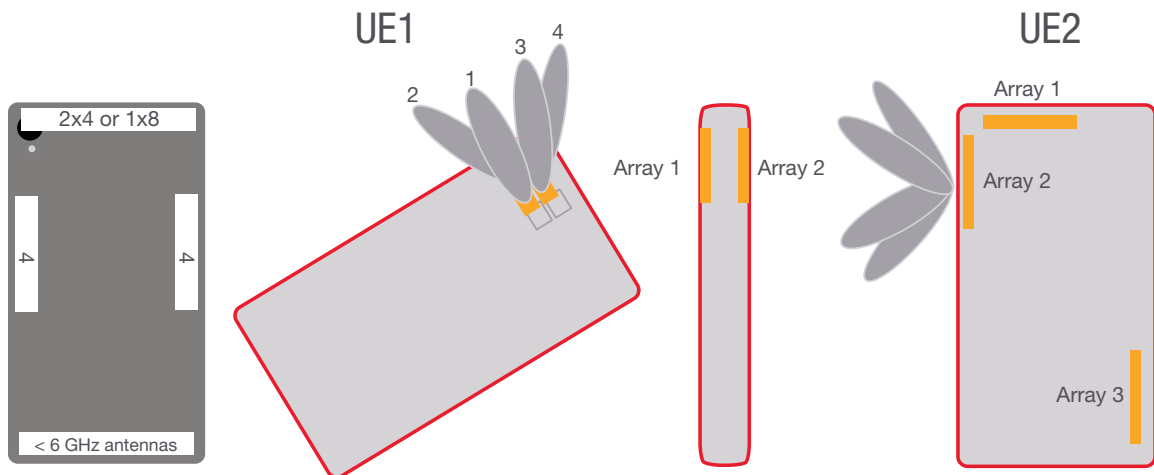

Figure 5.1. Device antenna locations and radiating beams from antenna arrays

OTA testing delivers critical insights during the prototyping phase. Chipsets, antennas, and integrated devices require validation in an over-the-air environment. A top-performing design requires designers to measure beam patterns both in 2D and 3D and understand beam width, sidelobe levels, null depths, and symmetry. In addition, validating beam steering and null steering functionality is critical, confirming the beam is pointing in the correct direction while maintaining the antenna gain under various conditions.

OTA Test Challenges and Solutions

Unlike traditional cabled tests, OTA tests introduce many new challenges, including path loss. Cabled test systems demonstrate well-behaved physical properties that need calibration to produce accurate and repeatable results. Calibrating OTA test methods is possible, but the process is more time-consuming and complex. With mmWave devices, excess path loss makes accurate OTA measurements more difficult. And while standards for mmWave testing are not yet fully defined by 3GPP, Keysight works closely with 5G chipset and device leaders to understand the OTA test challenges and deliver 5G ready solutions. Here is a summary of the new challenges:

- Excess path loss and distance at mmWave frequencies
- mmWave OTA test methods not fully defined
- Measuring device performance in real-world channel conditions

Excess path loss and distance at mmWave frequencies

OTA tests are typically carried out in either the near-field or far-field regions of the antenna array. The characteristics of the transmitted electromagnetic (EM) wave change depending on the distance from the transmitter. As the signal propagates from the antenna array, the signal becomes more developed. Shown in Figure 5.2, the amplitude of the peaks, sidelobes, and nulls of the radiation pattern evolve towards the far-field pattern.

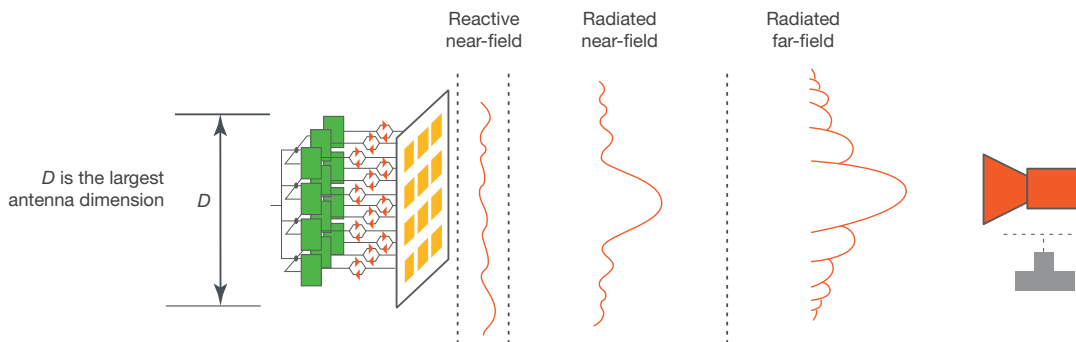

Figure 5.2. Beam properties at different distances from the antenna array

While near-field measurements are appropriate for some applications, 5G cellular communication links require using far-field assumptions. Due to the nature of radiated waves, the far-field distance and associated path loss grows bigger with the frequency. For example, the far-field region of a 4G LTE 15 cm device operating at 2 GHz starts at 0.3 meters and has a path loss of 28 dB. The far-field region of a 5G NR device operating at 28 GHz has a far-field distance of 4.2 meters and a path loss of 73 dB. If traditional methods were used, this would result in an excessively large far-field test chamber and a path loss that is too great to make accurate and repeatable measurements at mmWave frequencies. The distance also grows larger as the source antenna grows bigger, further compounding the size and path loss challenge.

Size D (cm)	2 GHz Distance (m) Path Loss (dB)	28 GHz Distance (m) Path Loss (dB)	43 GHz Distance (m) Path Loss (dB)
10	0.13 m 21 dB	1.87 m 66 dB	2.87 m 74 dB
15	0.30 m 28 dB	4.2 m 73 dB	6.4 m 81 dB
20	0.53 m 33 dB	7.4 m 78 dB	11.4 m 86 dB

Table 5.1. Estimated far-field distance and path loss for different radiating apertures

Successfully testing RF performance measurements such as transmitted power, transmit signal quality, and spurious emissions requires overcoming the path loss problem. To overcome the path loss and excessive far-field distance issues, 3GPP approved an indirect far-field (IFF) test method based on a compact antenna test range (CATR), as depicted in Figure 5.3.



Figure 5.3. IFF CATR method for 5G mmWave OTA testing

mmWave OTA test methods not fully defined

A typical OTA test solution includes an anechoic chamber, different probing techniques, and test equipment to generate and analyze the radiated signals in a spatial setting. The anechoic chamber provides a non-reflective environment with shielding from outside interference to generate and measure radiated signals of known power and direction in a controlled environment.

Moving to 5G, low-frequency tests are similar to 4G, but for mmWave, the following tests now require using over-the-air methods:

- RF performance — minimum level of signal quality
- Demodulation — data throughput performance
- Radio resource management (RRM) — initial access, handover, and mobility
- Signaling — upper layer signaling procedures

5G RF performance test methods are the most mature today. 3GPP study groups are still defining test methods for device demodulation and the more complicated RRM. The 3GPP allows three RF performance test methods to test UE devices. Each method has pros and cons, and one or more may be useful in characterizing your device based on the frequencies you need to test and the space constraints in your lab.

Direct far-field method

In the direct far-field (DFF) method, the DUT is mounted on a positioner that rotates in azimuth and elevation, enabling measurement of the DUT at any angle on the full 3D sphere. The direct far-field method can perform the most comprehensive tests measuring multiple signals. However, it requires a larger test chamber for mmWave devices; for example, a 4.2 m chamber for a 15-cm radiating device at 28 GHz results in excessive path loss. With the ability to measure multiple signals, this remains the preferred method for sub-6 GHz devices. A common test chamber arrangement looks like that in Figure 5.4.

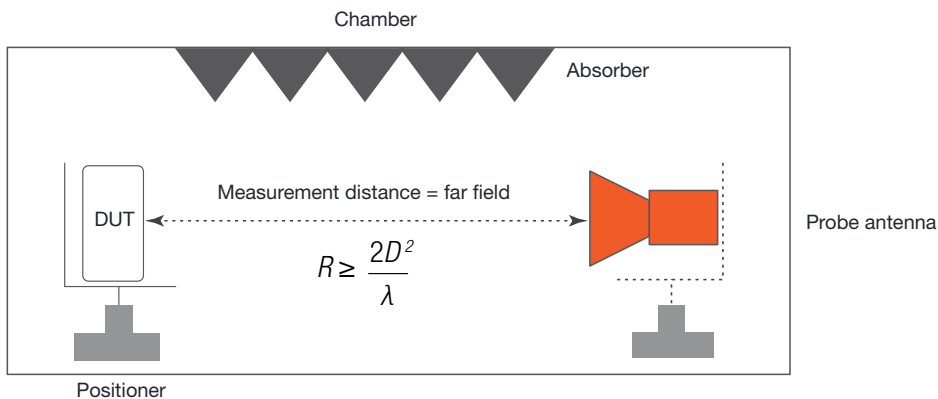

Figure 5.4. A wireless test chamber

Indirect far-field method

The IFF test method is based on a CATR that uses a parabolic reflector to collimate the signals transmitted by the probe antenna and create a far-field test environment (see Figure 5.5). While this method is limited to measuring a single signal, it provides a much shorter distance and with less path loss than the DFF method for measuring mmWave devices.

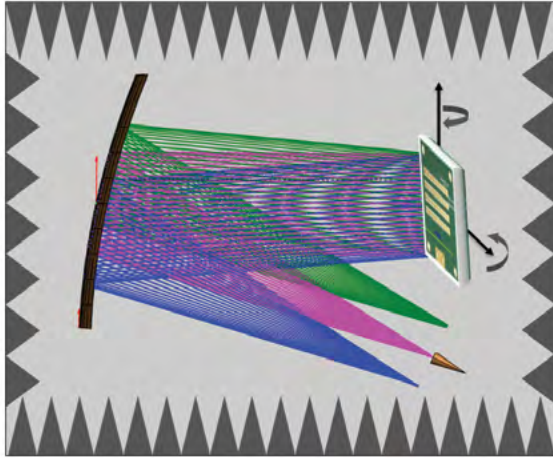

Figure 5.5. The physical arrangement of a CATR chamber

Near-field to far-field transform method

The near-field to far-field transform (NFTF) method samples the phase and amplitude of the electrical field in the near-field region and uses math to predict the far-field pattern (refer to Figure 5.6). While this is a compact, low-cost method, it is subject to transmitter interference that impacts measurement accuracy. It is also limited to single line-of-sight measurements.

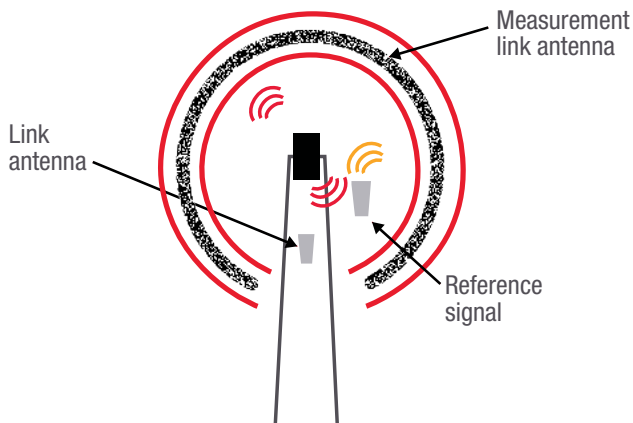

Figure 5.6. The concept of a NFTF test method

Since specific requirements and test methods are not fully defined, it will require a considerable amount of time and rework to implement an OTA test solution on your own. Keysight participates in the development of the 3GPP specifications and has early knowledge of requirements. Working closely with early adopters, we innovate on 5G OTA test methods, including chambers, probing, and the test equipment used to address a wide range of RF, demodulation, and functional performance test requirements in both mmWave and sub-6 GHz for 5G new radio designs.

Measuring device performance in real-world channel conditions

To achieve the highest degree of performance and reliability, designers must move beyond testing in a stable and controlled validation environment. A channel emulator is a tool that emulates real-world conditions while still providing control and repeatability for those conditions. Figure 5.7 shows a typical arrangement. This lets designers test a variety of new technologies, including wider signal bandwidths, mmWave frequencies, and beam steering with signal propagation issues like path loss, multi-path fading, and delay spread. As part of a complete testbed, a channel emulator enables the designer to characterize the device as part of a live full-stack system while emulating real-world radio conditions. A full-stack setup enables designers to test a broad range of situations and quickly identify any use cases that could potentially compromise the user experience in the finished device.

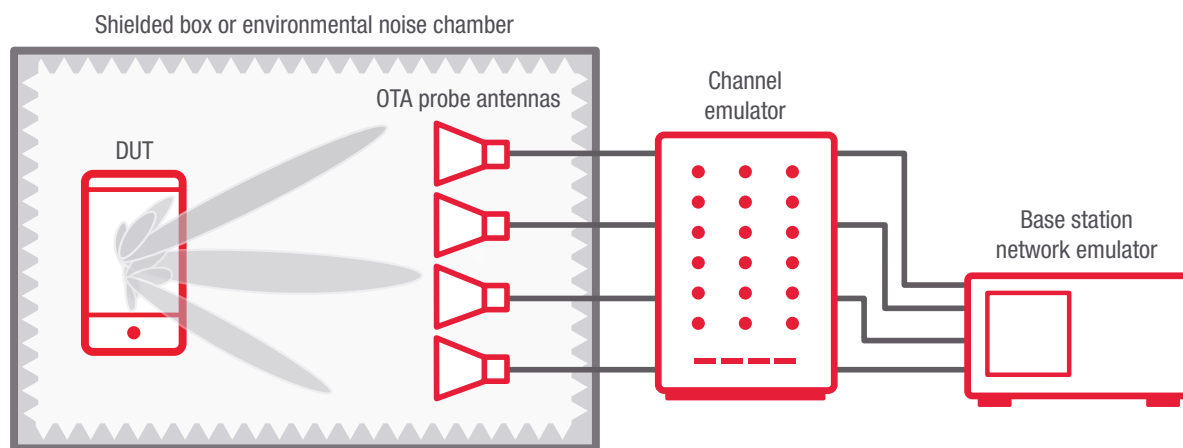
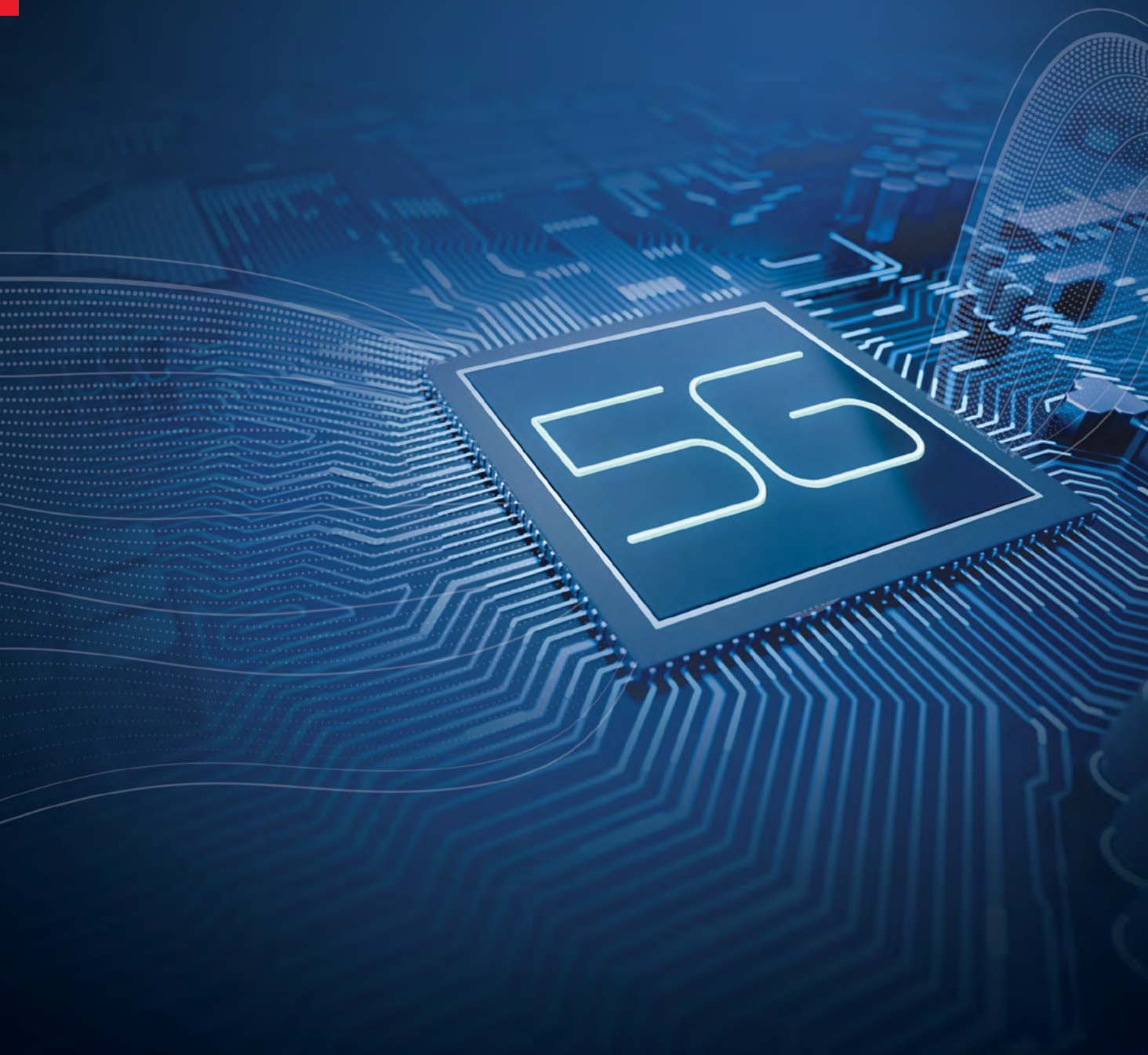

Figure 5.7. A base station emulator and channel emulator simulate real-world conditions

Section 3

Mastering the Complexity of 5G NR Chipsets and Devices





“Keysight’s end-to-end 5G test solutions have accelerated the development and validation of our new 5G designs across the workflow, from early prototyping to design validation and manufacturing.”

Woonhaing Hur
Vice President of System LSI Protocol
Development, Samsung Electronics

Chapter 6

5G: The Big Picture

5G promises a future where everything is connected, all the time, with faster, reliable, and near-instant connectivity. There are aggressive design goals across all three priority 5G use cases. In eMBB, specifications for target peak data rates of 20 Gbps in the downlink and 10 Gbps in the uplink are sufficient to support the streaming of 4K or 8K UHD videos. In URLLC, < 1 ms latency is required to support demanding applications such as self-driving automobiles and mission-critical drones. Also, in massive machine-type communication (mMTC), support for up to 200,000 devices per square kilometer is necessary for high-density IoT sensor networks. Achieving these goals requires new test methodologies and techniques for 5G NR chipsets and devices.

5G NR introduces new flexible numerology, more complex waveforms and channel coding techniques, frequencies that extend into mmWave, wider channel bandwidths, and advanced multi-antenna access schemes. Together these changes significantly increase complexity in design and test. As 5G standards are phased in, toolsets must also evolve to support designing and testing to the most recent specifications.

Various stages of the 5G product workflow need different tests. Early in design, simulation tools reduce design cycle times by providing insight into how chipsets and components will perform when integrated into a wireless device, and how that simulated device will interact with the environment around it. Later in design, tests of the design's RF performance in real-world environments confirm the device will operate as expected in the radio channel it was designed for, and how it will perform when connected to the network across both RF and mmWave spectrum.

Keysight partnered early with industry leaders to understand the complexities of 5G and to develop test cases for many different usage scenarios. Keysight's 5G NR design and test solutions span the entire workflow, from simulation, development, and design validation and test (DVT), to conformance and acceptance test, and ultimately to manufacturing and deployment. Our end-to-end coverage generates new insights that accelerate 5G innovation across the device workflow. See Figure 6.1.

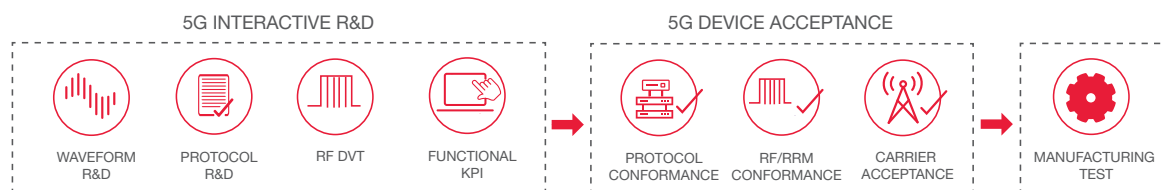

Figure 6.1. Keysight's 5G test solutions cover all aspects of development and manufacturing

A Common Theme: Stay Current with 5G NR Standards

The 3GPP has taken great pains to ensure that 5G NR Release 15 is designed to be forward-compatible with future releases. Release 15, representing Phase 1 of the 5G rollout, focuses on setting the foundation for eMBB and URLLC use cases. Phase 2 will continue the evolution of 5G NR with more optimization and support for new use cases beginning with 5G NR Release 16. New releases will bring new requirements for device manufacturers across the workflow.

For example, mmWave operating bands in FR2 (24.25 to 52.6 GHz) will require new multi-element antenna arrays configured with beam steering to overcome signal propagation issues at higher frequencies. New initial access procedures and beam tracking, beam refinement, and handover procedures require new test methods. As standards evolve, you need to ensure that you are testing to the latest specifications by regularly updating your 5G NR test software. As a result, you minimize the risk of parallel development, reduce costly rework, and ensure your designs meet evolving 5G NR requirements.

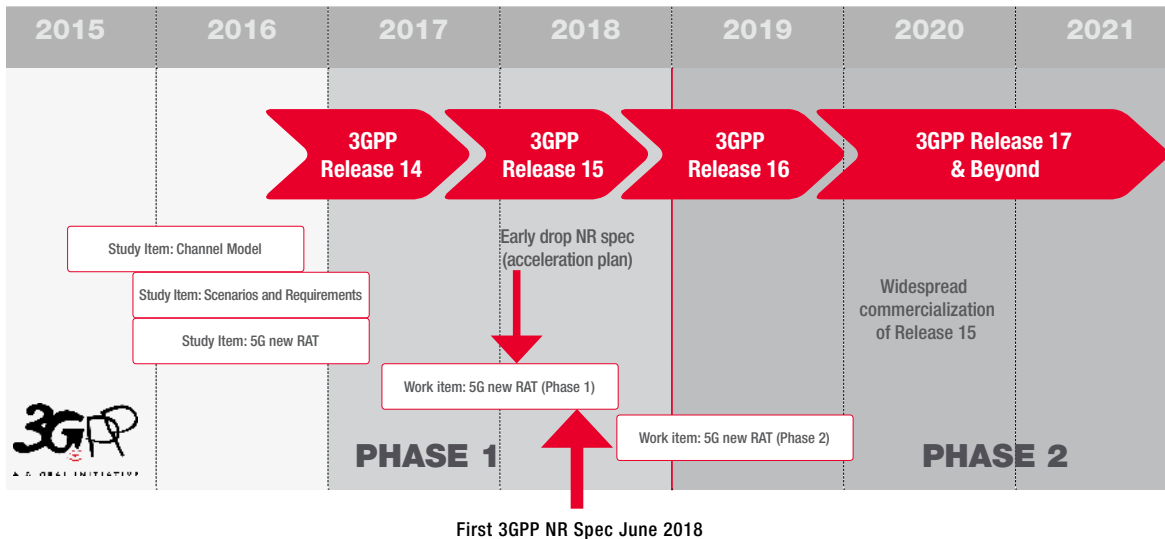

Figure 6.2. 3GPP timeline for 5G NR releases

Various use cases and network deployment options for Release 15 (illustrated in Figure 6.3) are still work in progress. As the standard continues to evolve, conformance test solutions need to support higher frequencies, wider bandwidths, and new physical layer features.

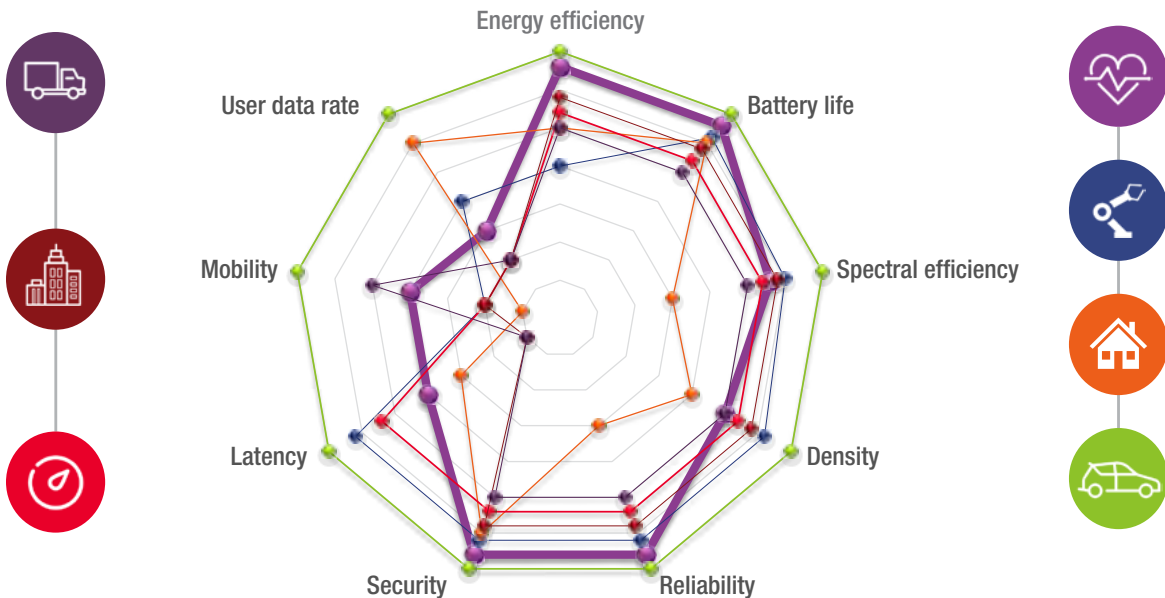

Figure 6.3. 5G NR use cases

Protecting Your Test Equipment Investment

You can future-proof your investments in test equipment by adopting instruments that can evolve as the standards change. Consider how quickly your test vendor can provide software releases to update to the latest test cases. Keysight, for example, participates alongside market leaders to define the 3GPP specifications and test cases. We work closely with device and base station original equipment manufacturers (OEMs) to bring industry-first designs to market before the standards are final. With this insight, test tool updates occur regularly and are submitted for validation by certification bodies at specific intervals.

As standards evolve to higher frequencies and wider bandwidths, scaling the test hardware is a physical limitation. One strategy is to purchase or lease test equipment that has broader coverage initially. Another approach is to use test equipment that easily scales as the requirements change. Aligning instrumentation to production needs is critical for device manufacturers to prevail in 5G. In addition to the 5G technology evolution, the cost of test is another primary concern for device manufacturers. The greater complexity of 5G technology mandates highly flexible instrumentation that reduces upfront costs and the overall cost of ownership. Device manufacturers need to control the costs of acquiring test assets with capital expenditures (CapEx) and operating the assets over their useful life with operational expenditures (OpEx). Modular test platforms and software licenses address this need.



Four insights to accelerate device designs:

1. Incorporate simulation into your workflow
2. Validate designs to work across the 5G wireless ecosystem
3. Test early, test often
4. Learn from market leaders

Chapter 7 Accelerating 5G NR Designs

5G NR Release 15, introduced in December 2017, lays the foundation for ultra-fast download speeds, reliable low latency connections, and connectivity to billions of IoT devices coming online over the next few years. With scalable numerology, flexible waveforms, and new spectrum, 5G NR provides a robust framework to address the many different use cases envisioned by the 5G IMT-2020, created by the International Telecommunication Union (ITU).

The new physical layer standards define a flexible air interface to support the many use cases expected in 5G. Designs for devices like smartphones, tablets, laptops, and wearables will need to operate in new spectrum with new enabling technologies.

Release 15 defines the specifications to support two of the three primary use cases: eMBB and URLLC. These use cases will enable high data throughput for streaming of high-definition video and movies, and low latency for applications like remote-controlled drones and virtual reality. Using new spectrum and the emerging 5G NR technologies means more complexity and greater challenges for design teams.

Companies that master the key challenges to implementing 5G NR will accelerate their deployment and time to market. These challenges include:

- new scalable numerology
- higher frequency and wider bandwidths
- MIMO and beam steering
- OTA testing
- 5G NR coexistence with other wireless communications systems

New spectrum and technologies introduced with 5G NR require you to think differently about how you design and test devices. Use the following five strategies to accelerate your device designs and get your products to market faster.

1. Incorporate Simulation Into Your Workflow

5G mmWave designs will use new beam steering and beamforming techniques to overcome signal propagation issues at mmWave frequencies. Emerging beamforming techniques like hybrid beamforming offer the advantage of fewer RF chains than previously used by analog beamforming. However, hybrid beamforming requires additional validation.

It is generally faster and more efficient to test new designs through simulation, before developing hardware. Simulation enables early performance characterization at the component level, circuit level, board level, device level, and even at the system level.

- With the multi-gigabit digital interfaces expected in 5G, design and simulation tools that evaluate signal and power integrity will help PC board designers evaluate the digital domain and ensure compliant designs.
- S-parameter and X-parameter simulations help identify design issues in components before dedicating resources to hardware prototypes. S-parameter simulations help to identify issues in linear components like phase shifters or attenuators, and large-signal X-parameter simulations help to understand issues in non-linear designs like amplifiers and mixers. Evaluating a design's performance through simulation can identify performance issues such as spurious intermodulation signals that can cause interference with nearby antennas.
- System-level simulation provides a way to evaluate, modify, and re-evaluate circuit and system parameters. For example, changing a circuit design parameter, such as the impedance at an antenna's inputs, enables quick evaluation of a simulated 3D antenna beam pattern.

Simulation makes the design job easier, helping you understand how a design will work when connected to the wireless communication link by identifying system-level performance issues early in the design cycle. Figure 7.1 is an example of a simulation. Simulation entails the integration of complex algorithms, such as parameters for channel models and for next-generation gNodeB (gNB) antenna patterns, into the simulation model to determine the impact of system-level performance under different link scenarios.

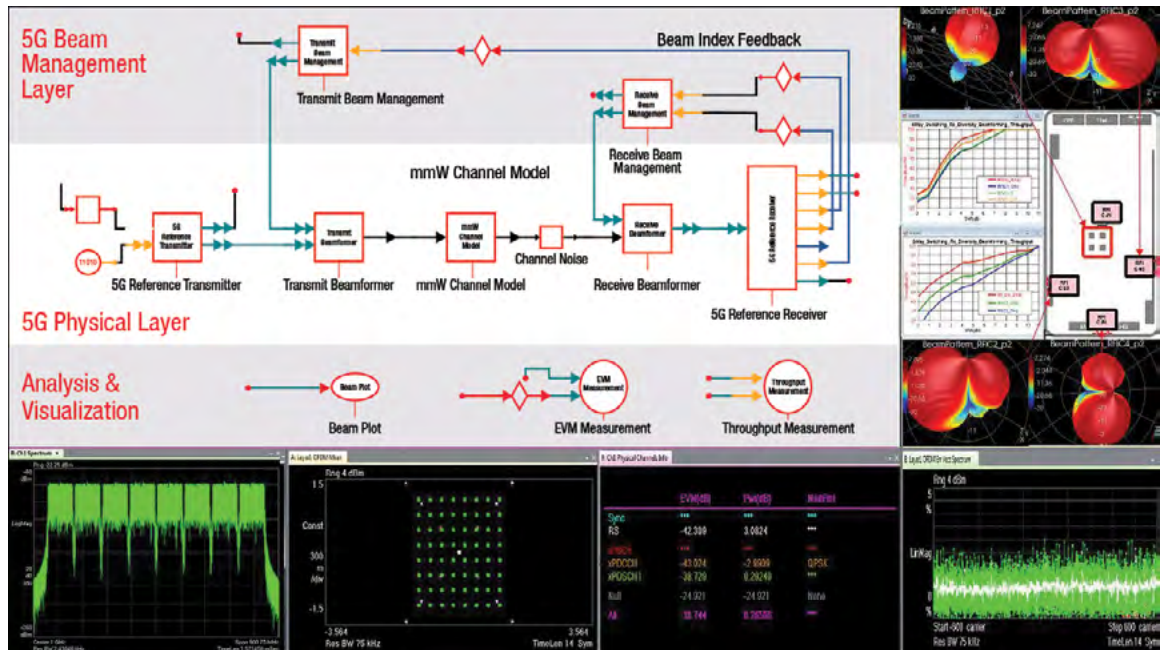

Figure 7.1. System-level tools such as PathWave System Design (SystemVue) Link Level Simulation help designers quickly iterate and validate designs before moving to hardware

Once a design is ready to move to hardware, test engineers can leverage the design parameters from the RF design and simulation tools and use them for validating hardware performance. If issues surface as the design moves through the workflow, test engineers can use the simulation data for troubleshooting and root cause analysis.

Design and simulation software enables product designers to optimize their designs and ensure device performance. Ultimately, adding simulation into the workflow reduces development time and identifies issues that could be costly to fix later in the design cycle.

2. Validate Designs to Work Across the 5G Wireless Ecosystem

5G NR network operators rely on chipsets, components, devices, towers, antenna arrays, transmission lines, and network software to produce good QoS for the consumer. Wireless chipsets and components are the building blocks of devices that need to connect to the network infrastructure and need to support the many different levels of services expected in the wireless ecosystem (see Figure 7.2):

- higher data rates to support eMBB use cases like UHD streaming
- latency and reliability improvements to support URLLC for mission-critical applications like remote, real-time surgery
- power consumption improvements and low data rates to support mMTC for the next generation of IoT

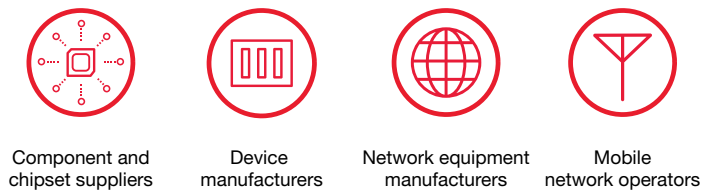

Figure 7.2. 5G NR must work across the wireless ecosystem

Chipsets need to manage the radio interface and the protocol layers including frequency and channel selection, time-slot coordination, power control, handovers between cells, and more. Identifying design issues early in the development cycle ensures that chipsets will perform the required tasks at each layer without any degradation in the quality of service.

Chipsets and devices need validation on the RAN to ensure they can perform under the many different use scenarios in 5G. Since there is no 5G NR infrastructure in place for device testing yet, test engineers will need to validate their devices in a lab under controlled environmental conditions. In the lab, using sophisticated test equipment, engineers test the device in different network scenarios to identify and resolve issues. For example, a network emulator can provide protocol messages with specific numerologies and frame structures to test the key performance indicators (KPIs) and validate the performance quality of the device before commercial deployment. An anechoic chamber with probing and OTA test capabilities facilitates the testing of the radiated signals in a spatial setting.

The best 5G NR design and protocol toolsets enable a seamless RF and protocol workflow approach for efficient development and test to the latest 4G and 5G standards. Validation of protocol and OTA tests ensures products work throughout the wireless network. You will need to:

- Test designs with 5G compliant waveforms
 - Simulate and validate MIMO and beamforming patterns
 - Test for throughput on the network
 - Validate over-the-air performance
-

Device battery performance can be a source of consumer frustration when there is excessive battery consumption due to poor component design. Therefore, it is important to test the device battery power consumption under various operating conditions and use scenarios in a lab environment. Designers using a network emulator that simulates real-world network commands can evaluate battery consumption under different conditions and can identify issues early in the design phase.

Network emulation tools help identify issues early in the design phase and can validate that designs meet expected performance and quality of service once integrated into a final product.

3. Test Early, Test Often

All 5G devices and gNBs are required to meet a minimum level of performance before they can be released into the market. 3GPP conformance tests define what and how to measure for compliance against the core specifications. Early in development, it is especially important to verify device performance under different conditions. If a device fails its conformance test, it goes back to the design phase, which significantly increases development costs and increases the risk of missing the market window. Figure 7.3 shows the process.

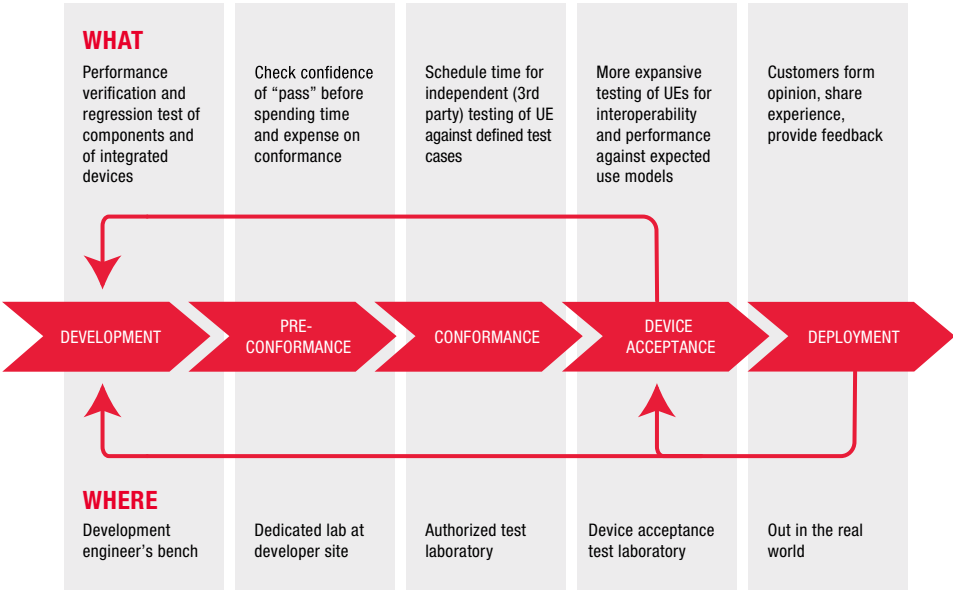

Figure 7.3. The development to deployment workflow requires testing new devices at multiple stages

Network operators require their own device acceptance tests to determine whether a device has adequate performance to use on their wireless network. Operators will stress test the device or UE under many different use case scenarios to ensure compliance with key performance indicators like high data throughput, reliability, or low latency.

5G devices will access multiple different radio access technologies (RATs), including 5G NR, 4G LTE, and Wi-Fi. Operators need to evaluate real-world performance and handovers between radio networks. This real-world evaluation is known as the inter-RAT handover test.

An additional complication of 5G NR is the two frequency ranges — FR1 from 410 MHz to 7.125 GHz and FR2 from 24.25 to 52.6 GHz. In 5G NR, many of the FR1 low-frequency tests are similar to 4G LTE tests. However, the use of mmWave multi-element antenna arrays integrated into RFICs requires OTA testing to validate beam steering in UEs and gNBs. It is important to validate designs using OTA test methods approved by 3GPP.

5G NR conformance standards continue to evolve. After defining the 5G NR conformance standards, approved 3GPP conformance tests may take months to finalize. Bringing devices to market without thoroughly testing RF performance, demodulation, RRM, and protocol signaling can result in a non-compliant product.

It is critical to have an end-to-end measurement solution that can test parameters early in development and provide testing to ensure successful pre-conformance, conformance, and device acceptance testing under real-world conditions. It is essential that the test solution includes fading and interference and incorporates 3GPP-approved OTA test requirements and methodologies.

To save time and money during the development process, start testing during the design phase, using reliable, accurate test equipment, and proven test methodologies. Identify and resolve issues early to eliminate the need for expensive rework and time-to-market delays.

4. Learn from Market Leaders

Market leaders work with standards' committees and test vendors to develop and validate new 5G technologies. Many different test cases are needed to support a broad range of capabilities, from very low to very high data rates, low latency, high reliability, and power-saving scenarios. From evaluating mmWave signal quality to validating throughput on a RAN, the 5G market leaders in the telecom industry — AT&T, Verizon, T-Mobile, China Mobile, NTT DoCoMo, SoftBank, Korea Telecom, Deutsche Telekom, Telefónica, KDDI, and Orange — are investing heavily in the commercialization of 5G.

At the core of 5G NR is the modem chipset. For example, Qualcomm's industry-first Snapdragon™ X50 5G modem chipset. Qualcomm needed to optimize its chipset performance without commercial networks or proven standards. New features and technologies including new numerologies, beam management, mmWave operating bands, larger channel bandwidths, and new multi-channel transmission techniques introduced many new challenges. Partnering with Keysight, Qualcomm was able to successfully emulate a 5G network and optimize the chipset performance in a mmWave OTA test scenario. Now, as 5G moves towards commercialization, Qualcomm can provide their OEM and operator partners with the confidence that their 5G modem will achieve the high data rates expected on a 5G RAN.



Figure 7.4. Modern smartphone with highly integrated antennas

Samsung needed to test a wide range of mmWave use cases using OTA test methods. They collaborated with Keysight to enable early 5G development and testing to support interoperability in the 5G ecosystem.

Service providers also need to validate 5G NR performance on new radio access networks. One of the first implementations in 5G was mmWave fixed wireless access (FWA). 5G market leaders in the telecoms industry have conducted field trials in select cities. Demonstrating line-of-sight (LOS) and non-line-of-sight (NLOS) communication links at mmWave frequencies with wider bandwidths is a key challenge. Using a 5G field measurement solution, service providers measured and verified mmWave operating bands with real-world reflections. They measured penetration loss for indoor and outdoor scenarios and took their measurement results back to the lab for further analysis and reporting.

You don't have to face these difficult challenges on your own. Engage with a test partner who works with leaders across the wireless ecosystem to benefit from their experience. Your test partner can help you select a 5G NR solution with the most current standard, so that you can accelerate your time to market.

“We are proud of our 5G R&D progress, as well as the recent 5G public demonstrations, and are delighted to be working with Keysight as the leading 5G test solutions provider to help fast-track the release of our first commercial 5G phone. Keysight’s close relationships with our 5G chipset and operator partners afford the company valuable 5G insights and expertise, which makes them the ideal partner for OPPO.”

Levin Liu,
Global Vice President and Head of the
OPPO Research Institute at Shenzhen, China





Chapter 8 Spotlight on 5G mmWave Waveform Evaluation²

Waveform design is a fundamental issue for mmWave communication. In recent years, several multi-carrier (MC) and single-carrier (SC) waveforms have been proposed for the 5G air interface. The challenge when designing MC waveforms is that the hardware used for building transceivers can have many imperfections — namely oscillator phase noise and a nonlinear power amplifier (PA), which get more pronounced with increasing carrier frequencies. The design/evaluation of waveforms must take into account these hardware impairments, especially for mmWave communications.

² The work detailed in this section is partly funded by the 5G PPP mmMAGIC project, a European Commission H2020 program under grant agreement No. 671650.

Assessing Waveform Candidates

Mobile radio communication above 6 GHz is characterized by large channel bandwidths, extreme data rate requirements, harsh propagation conditions, severe RF impairments, a massive number of antennas, and small-sized low-cost base stations. Several key performance indicators (KPIs) that are important for the assessment of waveforms are as follows:

- **Spectral efficiency:** Spectral efficiency is vital to meet extreme data rate requirements. In general, spectral efficiency is more important at lower carrier frequencies than at very high frequencies, where large channel bandwidths are likely to be available for mobile communication.
- **MIMO compatibility:** Massive MIMO is the driving technology to provide high spectral efficiency, via spatial multiplexing, and greater coverage, via beamforming. Beamforming is instrumental to overcome high propagation losses at mmWave frequencies.
- **Peak-to-average-power-ratio (PAPR):** A low PAPR is essential for power-efficient transmissions from devices (e.g., uplink). It is noteworthy that small, low-cost base stations are envisioned at high frequencies. Therefore, low PAPR is also important for the downlink.
- **Robustness against hardware impairments:** Waveform robustness is critical, especially with phase noise and PA nonlinearities. Phase noise increases as a function of carrier frequency, while the impact of a nonlinear PA increases as a function of signal bandwidth.
- **Robustness to channel time-selectivity and frequency-selectivity:** Depending on the scenario — line-of-sight (LOS)/non-line-of-sight (NLOS) — beamforming algorithm, and user mobility, the channel can have different combinations of high/low-frequency selectivity and high/low time selectivity.
- **Time localization:** Time localization is important to enable efficient TDD transmission and to support low latency applications.
- **Frequency localization/out-of-band emissions:** Frequency localization is relevant to support the potential coexistence of different services by multiplexing different waveform numerologies in the frequency domain.
- **Transceiver baseband complexity:** Low baseband complexity is very important to enable efficient baseband processing at large bandwidths, especially from the receiver perspective.

For mmWave communication, the most important KPIs are robustness to hardware impairments, PAPR, time/frequency localization, compatibility with MIMO, and computational complexity. Although spectral efficiency is always an important KPI to meet high data rate requirements, it is more important at lower carrier frequencies where spectrum is scarce. Above 6-GHz communication, spectral efficiency is not a major performance indicator due to the large channel bandwidths envisioned at mmWave bands.

Waveform Candidates

Both MC and SC waveforms have been proposed for the 5G air interface. The MC candidates include CP-OFDM, windowed (W)-OFDM, pulse-shaped (P)-OFDM, unique-word (UW)-OFDM, universal-filtered (UF)-OFDM, and filter-bank multi-carrier (FBMC) with offset quadrature amplitude modulation (OQAM). The SC candidates include DFT-s-OFDM and zero-tail (ZT)-DFT-s-OFDM.

Due to its desirable features, the CP-OFDM waveform is currently used in LTE for downlink transmissions. These features include robustness to frequency selective channel, easy integration with MIMO, very good time localization, and a low complexity baseband transceiver design. The main drawbacks of OFDM are high PAPR and poor localization in frequency.

The FBMC-OQAM waveform is based on filter-bank implementations where each subcarrier is filtered. FBMC is less localized in time, but well localized in frequency. The choice of prototype filters controls the localization in both the time and frequency domains. The cons of the FBMC-OQAM waveform include its non-straightforward compatibility with MIMO techniques and increased complexity compared to OFDM.

In a UF-OFDM waveform, groups of adjacent subcarriers, which can be flexibly defined, are digitally passband filtered. The sub-band filtering with spectrally wider filters, as compared to FBMC, has the advantage of a shorter impulse response in the time domain, thus making the symbol extension in the time domain comparable to the CP of OFDM. Some of the key benefits of the UF-OFDM waveform are low out-of-band spectral emissions, and the ability to operate each sub-band with a different numerology to adapt dynamically to different deployment scenarios.

The W-OFDM waveform improves the frequency localization of OFDM by applying low complexity windowing or sub-band filtering, which enables smoother temporal transitions between successive OFDM symbols. This windowing or filtering can be employed at either the transmitter or the receiver, or both the transmitter and receiver.

In the DFT-s-OFDM waveform, data is spread with DFT, followed by subcarrier mapping and inverse fast Fourier transform (IFFT). Its main benefit is low PAPR. Other important advantages include low complexity, frequency domain equalization, and good time localization. The cons of the DFT-s-OFDM waveform are poor localization in frequency and performance degradation in the high signal-to-noise ratio (SNR) region, as compared to OFDM in frequency selective channels.

Figure 8.1 illustrates a common framework for the synthesis of the various candidate waveforms. Here, each waveform can be generated by selectively enabling or disabling certain blocks or operations. Table 8.1 summarizes the synthesis blocks (operations) and the associated design parameters. Note that the blocks necessary to generate the CP-OFDM signal are shown in white, whereas the extra blocks required for the generation of any of the other waveforms are highlighted in grey.

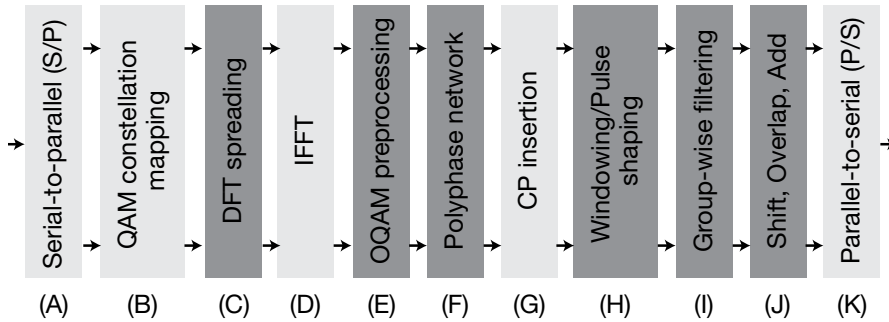

Figure 8.1. Waveform synthesis: All waveforms can be synthesized by sequentially activating certain blocks in this diagram

Waveforms (MC/SC)	Design parameters	Synthesis operations
CP-OFDM (MC)	Sub-carrier spacing, FFT size	A, B, D, G, K
W/P-OFDM (MC)	Sub-carrier spacing, FFT size, CP length, window/pulse shape	A, B, D, G, H, K
UF-OFDM (MC)	Sub-carrier spacing, FFT size, CP on/off, sub-band filters, guard time	A, B, D, I, K
FBMC-OQAM (MC)	Sub-carrier spacing, FFT size, prototype filter, overlapping factor	A, B, D, E, F, J, K
DFT-s-OFDM (SC)	Sub-carrier spacing, FFT size, CP length, DFT block size	A, B, C, D, G, K

Table 8.1. Synthesis operation and design parameters

Hardware Impairment Models

The hardware used for building transceivers can have many imperfections, and these imperfections get more pronounced with increasing carrier frequencies. Hardware impairments distort the transmitted and received signal and lead to increased EVM and/or reduced effective signal to interference and noise ratio (SINR). Further impacts of hardware impairments include increased out-of-band (OOB) emission and interference to other links or users. Consequently, when designing or evaluating waveforms, hardware impairments must be taken into account. The following parts will briefly describe the modeling and the impact of oscillator phase noise and nonlinear PA.

Phase noise

Phase noise is typically caused by local oscillator (LO) instability. This means that the LO output spectrum is not an ideal Dirac impulse, but instead exhibits a skirt-like shape, as shown in Figure 8.2. Because of phase noise, the received signal samples will have random time-varying phase errors. In an OFDM system, phase noise causes common phase error (CPE) and intercarrier interference (ICI), which results in degraded EVM performance.

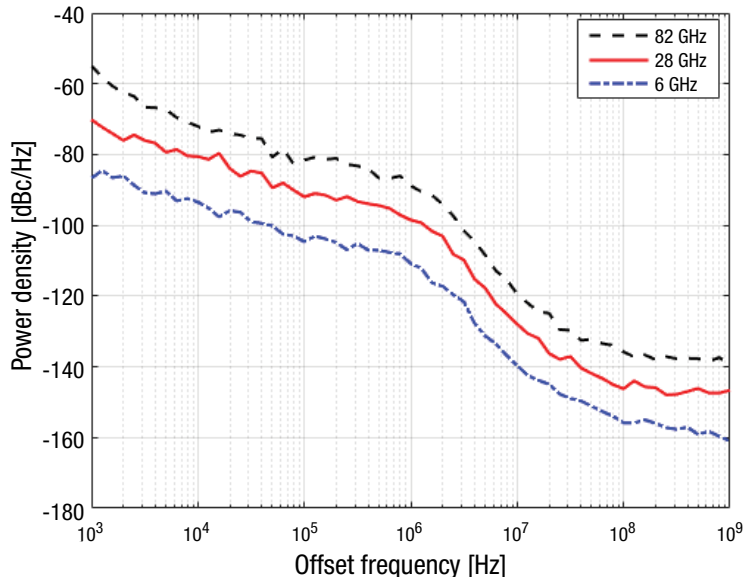

Figure 8.2. Power spectral density of the phase noise (low mode)

Phase noise also causes leakage between adjacent channels, which is detrimental in near-to-far scenarios of a UE constellation in a cell. Phase noise also has adverse effects on interference cancellation schemes.

Generally, the phase-noise variance grows with the square of the carrier frequency. It is inversely proportional to the power consumption of the complete frequency generation (PLL, reference, etc.). This makes it an important effect in mmWave systems, especially those striving for low power consumption, as it may limit throughput. Careful selection of carrier bandwidth and sub-carrier spacing is therefore crucial, as is the design of the phase-tracking reference signal.

It is possible to compensate for phase noise using various approaches. For example, the CPE can easily be estimated (and corrected) in the frequency domain as the common phase rotation of the constellation, using scattered pilots. ICI may be modeled as additive noise — though not always Gaussian — and is usually hard to compensate. It requires denser pilots for phase noise and channel tracking and can be computationally intensive. With relatively large subcarrier spacing, it may be sufficient to compensate the CPE only. This is implicitly done if the estimated channel transfer function, using the scattered pilots (which include the common phase rotation), is used for equalization.

Nonlinear Power Amplifier

Due to physical constraints, it is generally understood that the practical PA efficiency at mmWave frequencies is much less than that at centimeter-wave frequencies. As the bandwidth and modulation order increase to achieve high data rates at mmWave bands, the PAPR of communication signals increases correspondingly. Therefore, it is expected that mmWave PAs will likely work in the nonlinear region during transmission. Unless suitable PAPR-reduction techniques are deployed, this may further limit the power efficiency of the PA. However, since the PAPR of OFDM signals tends to grow logarithmically, the PAPR issue is not considerably worse than in the sub-6 GHz case.

When signals with a large dynamic range go through a nonlinear PA, they suffer from nonlinearity effects, resulting in both in-band distortion and spectral regrowth. While in-band distortion increases the EVM of the transmitter signal, spectral regrowth causes adjacent channel interference. The power series model, or polynomial model, is widely used in modeling memoryless nonlinear PAs. The model is given by:

Waveforms (MC/SC)	Design parameters
Nonlinear order K	5
Output 1-dB gain compression power	0.01 W
Output third-order intercept power	0.1 W
Saturation power	0.032 W
Gain compression at saturation	3 dB

Table 8.2. Nonlinear PA parameter settings

Performance Evaluations

To better understand the impact of hardware impairments on the candidate waveforms (CP-OFDM, DFT-s-OFDM, W/P-OFDM, UF-OFDM, FBMC-OQAM), their performance must be properly evaluated in the presence of the impairments. For this discussion, link-level evaluations of the waveforms are performed using SystemVue software.

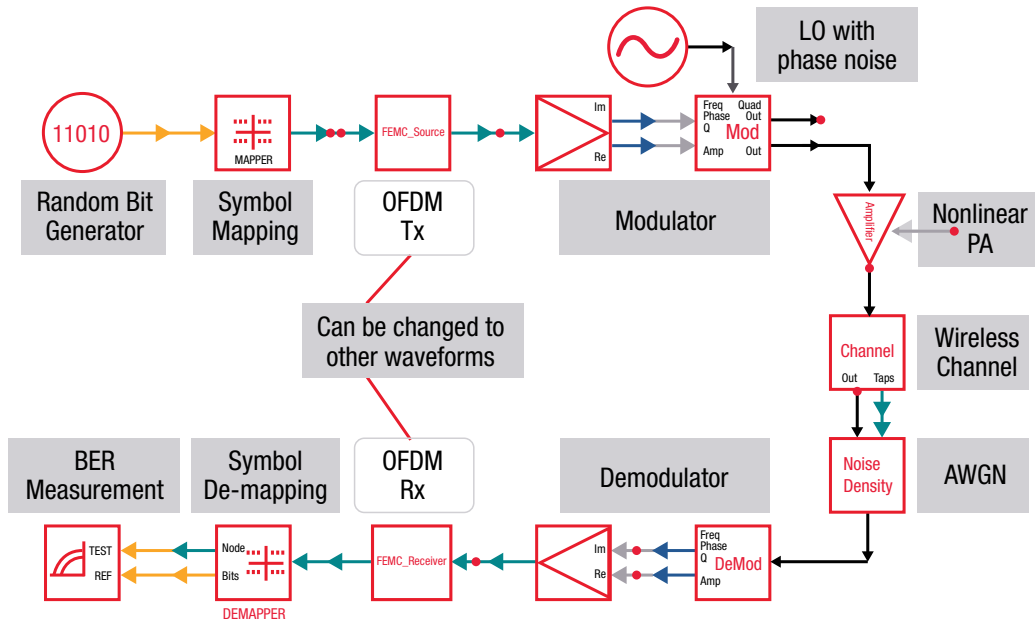

Figure 8.3. Example simulation chain with OFDM in PathWave System Design (SystemVue)

Figure 8.3 illustrates the end-to-end simulation chain for an OFDM waveform which is composed of basic signal processing components. For a fair comparison between the different waveforms, the same reference simulation chain is used for each performance evaluation. Different waveform source generators and receivers are plugged into the reference simulation chain under common simulation assumptions (Table 8.3). For these evaluations, scattered pilot-based channel estimation was used, which also compensates for CPE.

Parameters	Settings
Carrier frequency	28 GHz
Sampling frequency	122.88 MHz
FFT size	2048
Subcarrier spacing	60 kHz
Number of active subcarriers	1200
Signal power	0.01 W
Modulation and coding scheme	16 QAM
Antenna configuration	SISO
Channel model	AWGN
Symbols per subframe	7 (1 preamble + 6 data symbols)
Pilot design	Every 8 subcarriers, Zadoff-Chu
Hardware impairments	“low mode” phase noise & nonlinear PA

Table 8.3. Summary of main simulation parameters

Figures 8.4 and 8.5 plot the bit error rate (BER) and EVM performance of the waveforms under different hardware impairments. Notice that the EVM and BER performance of the considered waveforms is only slightly reduced in the presence of phase noise.

Generally speaking, MC waveforms are sensitive to phase noise. However, with phase noise compensation and sufficiently large subcarrier spacing, these waveforms are robust to phase noise. In this case, scattered pilot-based channel estimation compensated for CPE. When nonlinearity in the PA is included in the system, both the BER and EVM performance degrade compared to the case with an ideal linear PA.

It is also interesting to note that there is no significant difference in the BER and EVM performance among the various candidate waveforms.

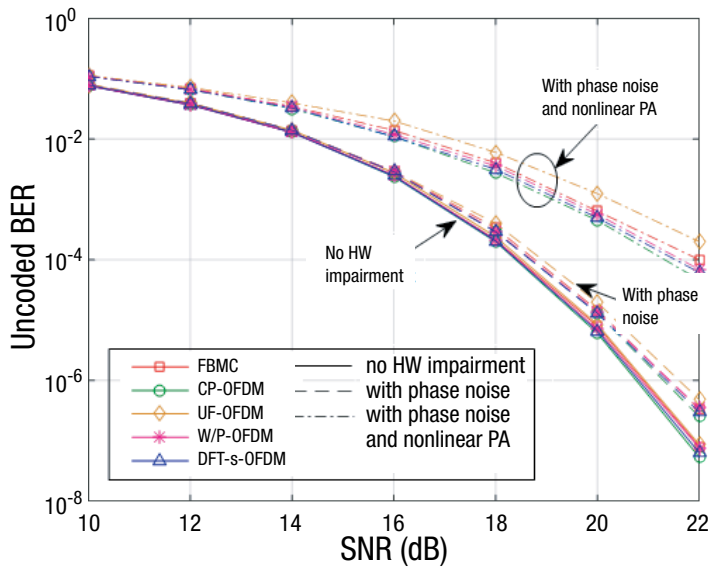

Figure 8.4. BER performance of different waveforms with/without hardware impairments

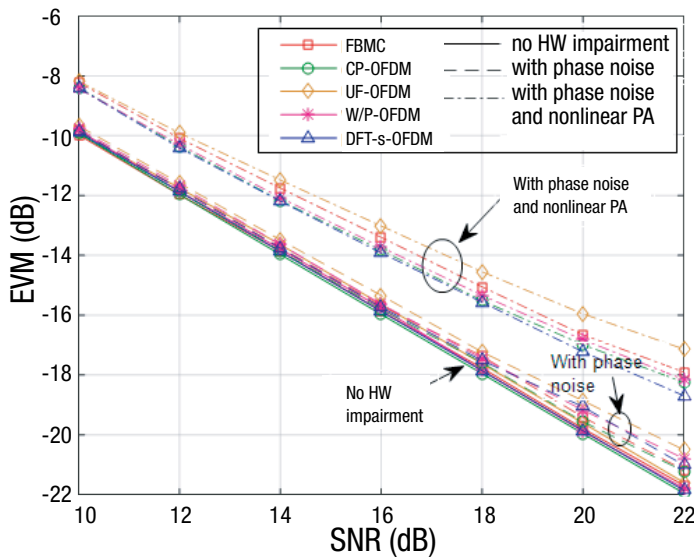

Figure 8.5. EVM performance of different waveforms with/without hardware impairments

Figure 8.6 shows the complementary cumulative distribution function (CCDF) of the PAPR of the different waveforms. The graph clearly shows that the PAPR performance of the FBMC-OQAM and W/P-OFDM waveforms is similar to that of CP-OFDM. The UF-OFDM waveform, on the other hand, has a slightly higher PAPR than the CP-OFDM waveform. When comparing it with an SC waveform (e.g., DFT-s-OFDM), it becomes obvious that a common drawback of MC waveforms is their high PAPR.

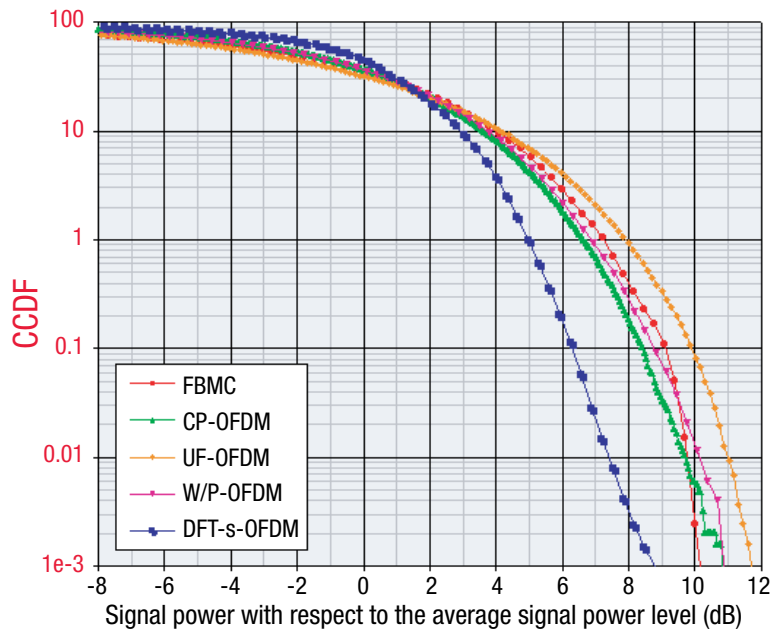

Figure 8.6. CCDF of PAPR of different waveforms

Figure 8.7 shows the power spectral density (PSD) of different waveforms without any hardware impairments. The CP-OFDM and DFT-s-OFDM waveforms have much higher OOB power leakage than the other waveforms. Specifically, FBMC has the lowest OOB emission among all candidate MC waveforms. It is worth mentioning that the OOB emission of each waveform depends on the parameter setting (e.g., overlapping factor for FBMC, filter design for UF-OFDM, and windowing/pulse function for W/P-OFDM). By adjusting these parameters, it is possible to balance the localization of a waveform in the time and frequency domains.

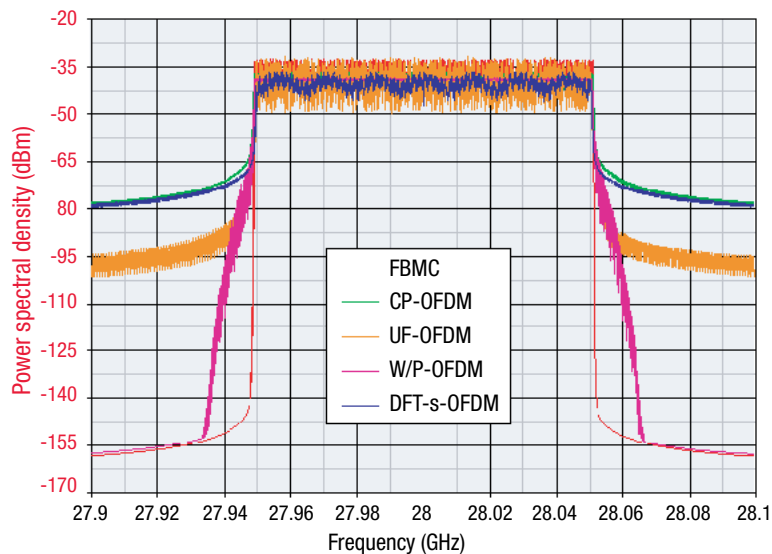

Figure 8.7. PSD of different waveforms without hardware impairments

Figure 8.8 shows the PSD of different waveforms subject to phase noise. Compared with the results in Figure 8.7, the sharp spectrum roll-off provided by the FBMC-OQAM, W/P-OFDM, and UF-OFDM waveforms is significantly reduced with the inclusion of phase noise. It is still much lower than that of the CP-OFDM and DFT-s-OFDM waveforms. The sharp spectrum roll-off promised by these waveforms is difficult to achieve when a nonlinear PA is taken into account (Figure 8.9). This is due to spectral regrowth from nonlinearity of the PA. For low-power transmission (relatively higher power back-off), there can still be an OOB advantage over CP-OFDM.

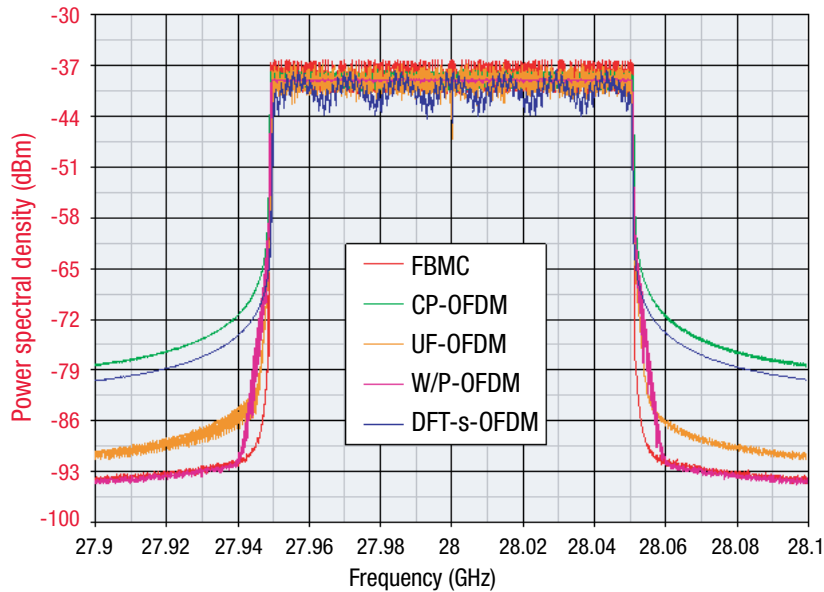

Figure 8.8. PSD of different waveforms with phase noise

These comparisons show that the studied waveforms have similar EVM/BER performance with and without hardware impairments. The new waveforms (e.g., W/P-OFDM, FBMC, UF-OFDM) exhibit improved spectral confinement compared to CP-OFDM and DFT-s-OFDM. However, the improvement gets smaller with the use of hardware impairments (e.g., phase noise and nonlinear PA). For a nonlinear PA with high-power transmission, similar OOB emissions are observed for all waveforms.

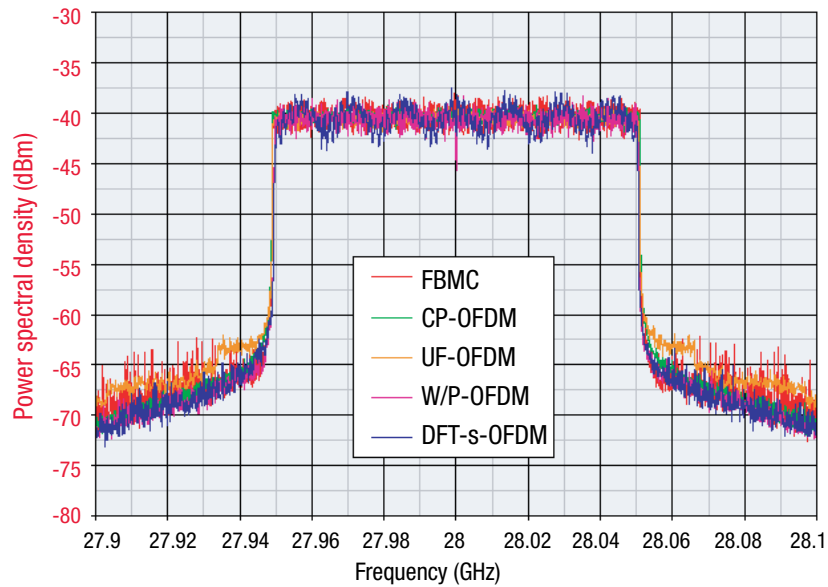

Figure 8.9. PSD of different waveforms subject to nonlinear PA and high-power transmission

Choosing the Right Waveform for mmWave

The choice of which waveform to use for mmWave communication is important. You need to consider the effect of hardware impairments such as phase noise and nonlinear PAs. Evaluating the performance of several 5G candidate waveforms in the presence of hardware impairments demonstrates that all waveforms exhibit similar EVM/BER performance. The evaluation also reveals that with phase noise compensation and sufficiently large subcarrier spacing, MC waveforms are more robust to phase noise.

Additionally, the use of filtering/windowing components extended to OFDM signals can improve the spectral confinement (i.e., steep spectrum roll-off at OOB emissions). However, hardware impairments reduce these improvements. In all cases, PathWave System Design (SystemVue) provides an ideal tool for accurately evaluating waveform performance.

A hand holding a glowing white circle containing the letters '5G'. The background is a cityscape at dusk or dawn, with a network of white lines connecting various points, symbolizing 5G connectivity.

5G

Three tips to help prepare for 5G NR conformance and device acceptance tests:

1. Use minimum requirements as a guide for conformance
2. Address test system complexity with flexible, high-performance instruments
3. Ensure test case coverage with standard platforms

Chapter 9 Passing 5G NR Conformance

As 5G accelerates to commercialization, device and base station companies must follow specific steps to launch 5G products to market. It has been nearly ten years since the 4G LTE introduction. While 4G had significant improvements over 3G, the changes in 5G NR are more disruptive, and getting approval to go to market is now a considerable challenge.

Chipsets and devices will operate at higher frequencies with wider transmission bandwidths. Devices and base stations will use new access technologies to make connections, and networks continue to evolve to manage more data, more users, and different levels of service. 4G and 5G NR networks must work in harmony to provide seamless services to users.

Passing conformance and device acceptance tests is a significant challenge for device and base station companies to overcome. The following information is important to keep in mind when preparing for 5G NR conformance tests:

- conformance test requirements and test methods continue to evolve because of 3GPP's continued work
- FR2 significantly increases the test complexity
- expect exponential growth in the number of test cases
- standards continue to evolve to include higher frequency ranges, wider channel bandwidths, and increasing coexistence scenarios

Preparing for pre-conformance and conformance tests is critical. 5G NR introduces new test challenges due to incomplete test requirements, new mmWave operating bands, more complex tests, and standards that continue to evolve. Companies that prepare for conformance and device acceptance tests will accelerate their time to market.

Although the standards are not yet complete, testing of 5G products is underway. Device and base station providers must carefully select test equipment for conformance test. Here are four insights to help prepare for 5G NR conformance and device acceptance tests:

1. Use the Minimum Requirements as a Guide for Conformance

Devices and base stations need to undergo conformance testing before release to the marketplace. The 3GPP radio access network (RAN) working committees define the conformance goals. It is important to look back at the process that generates the specifications to understand them.

The IMT-2020 vision specifies three primary use cases for 5G NR – eMBB, URLLC, and mMTC. The 3GPP study item technical report (TR) 38.913 describes the KPIs for the different deployment scenarios, as well as V2X requirements. KPIs include targets for peak data rates, spectral efficiency, latency, reliability, and UE battery life. The RAN working groups develop the 5G NR specifications based on the IMT-2020 goals (see Table 9.1). 5G NR documents are available in the 38.xxx series documents located on the 3GPP website (3gpp.org).

	Study items for new radio access technology	Specifications
RAN1 Radio layer 1	TR 38.802 Physical layer aspects	TS 38.201 – TS 38.215
RAN2 Radio layer 2 and radio layer 3	TR 38.804 Radio interface protocol aspects	TS 38.300 – TS 38.331
RAN3 Radio network	TR 38.801 Radio access architecture and interface	TS 38.401 – TS 38.474
RAN4 Radio performance and protocol	TR 38.803 RF and co-existence aspects	TS 38.101 – TS 38.173 (+ TS 38.307)
RAN5 Mobile terminal conformance tests	TR 38.80x	TS 38.508 – TS 38.533

Table 9.1. 3GPP RAN working groups generate technical reports and technical specifications

Conformance tests ensure a minimum level of performance in UEs and base stations. Table 9.2 lists the 3GPP requirement documents. Conformance tests validate transmitter characteristics, receiver characteristics, and their performance.

Additional tests for devices include RRM and protocol testing. RF parameters are the basis of base station tests. UEs have a much longer list of conformance requirements that add radio access, signaling, and demodulation tests. UEs must also undergo validation by certification organizations, such as Global Certification Forum (GCF) and PCS Type Certification Review Board (PTCRB), to ensure 5G commercial devices comply to the latest 3GPP specifications. To ensure UE devices operate as expected on a specific network, they must pass acceptance tests by mobile network operators.

Base station or UE conformance test specification	Specifications
Base stations	
TS 38.141-1 TS 38.141-2	Part 1: Conducted testing in FR1 Part 2: Radiated testing for specific base station configurations in FR1 & FR2
Devices	
TS 38.521-1/2/3/4	5G NR UE radio transmission & reception: Range 1 standalone – FR1 conducted tests Range 2 standalone – FR2 radiated tests Range 1 & 2 interworking operation with other radios (NSA) – FR1 conducted & FR2 radiated Performance requirements (SA and NSA) – FR1 conducted & FR2 radiated
TS 38.523-1/2/3	5GS UE protocol conformance: Protocol Applicability of protocol test cases Protocol test suites
TS 38.533	5G NR radio resource management (RRM) (SA and NSA): – FR1 conducted & FR2 radiated

Table 9.2. 3GPP conformance tests for base stations and devices

Conformance test specifications originate from the minimum requirements specified in the 3GPP RAN2 and RAN4 documents. The conformance specification takes into consideration the test measurement uncertainty (MU) and a test tolerance (TT). Operators and device and base station OEMs specify the test requirements for each test. The minimum requirement specification is more stringent than the conformance specification. Designers can use the minimum requirement as a guide to test their 5G NR products until 5G NR conformance test requirements are complete. The minimum test requirements ensure that 5G products pass the final conformance test cases.

2. Address Test System Complexity with Flexible, High-Performance Instruments

5G NR can operate in FR1 and FR2. The lower frequency tests in FR1 are similar to 4G LTE tests. Conversely, FR2 testing stresses the test solution in many new ways. The test equipment required to test the FR2 range needs to cover wider frequencies and bandwidths. The requirements are up to 60 GHz for measuring spurious emissions, and up to 1.6 GHz bandwidth to support inter-band carrier aggregation.

According to conformance requirements, all FR2 device and base station tests as well as some FR1 base station tests, require radiated testing. This implies OTA testing, which introduces additional test challenges. Primary challenges include greater path loss and higher measurement uncertainties that make it difficult to achieve measurement accuracy.

Pre-conformance and conformance tests require a calibrated OTA test solution that covers all the requirements outlined in the 3GPP conformance documents listed in Table 9.2. Example tests include transmitted power, signal quality, intermodulation, spurious emissions, and blocking tests.

A test solution for mmWave designs needs to accommodate higher frequencies with wider channel bandwidths. The solution must also have an adequate SNR to detect and demodulate 5G signals accurately. When testing transmitters, for example, SNR is critical in the signal analyzer to ensure accurate EVM and adjacent channel leakage ratio (ACLR) measurements.

In an OTA test setup where path loss is an issue, a vector signal generator (VSG) with high output power and low EVM will ensure adequate SNR for testing 5G receivers.

A selectivity and block test setup requires multiple mmWave signal generators to provide the fixed reference channel, a modulated interfering signal, and a continuous wave (CW) signal, as shown in Figure 9.1. High output power is also important to overcome higher path losses at mmWave frequencies.

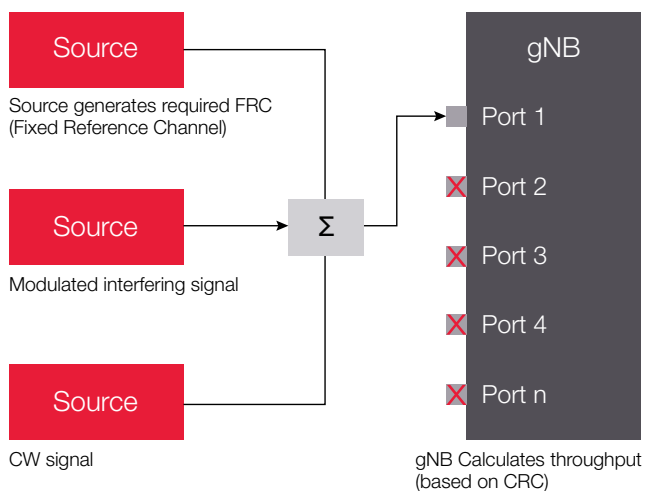

Figure 9.1. Base station receiver intermodulation conducted test setup for part 1 (part 2 is OTA)

When specifying a 5G test solution, it is important to select test equipment that has adequate range to cover the requirements from sub-6 GHz to the different mmWave operating bands. Since many tests require multiple sources for receiver tests, and multiple analyzers for transmitter tests, a modular platform will reduce the test footprint and simplify the test setup.

3. Ensure Test Case Coverage with Standard Platforms

5G NR aims to support many different use cases and deployment scenarios over FR1 and FR2 operating bands. The test combinations create a vast matrix of test cases. For example, as shown in Figure 9.2, 5G NR can operate in SA or NSA mode. In SA mode, the 5G NR connects directly with the 5G next-generation core (NGC) network and operates independently of 4G. However, it will take time to roll out 5G networks. 5G NR will rely heavily on the 4G infrastructure to maintain connectivity as 5G devices travel through the network. Devices need validation for one or multiple deployment options. Evolved Universal Terrestrial Radio Access (E-UTRA) and 5G NR dual connectivity (EN-DC) also require testing. With the addition of MIMO and multiple carrier aggregation combinations across various operating bands, this equates to more than 1,000 UE test cases.

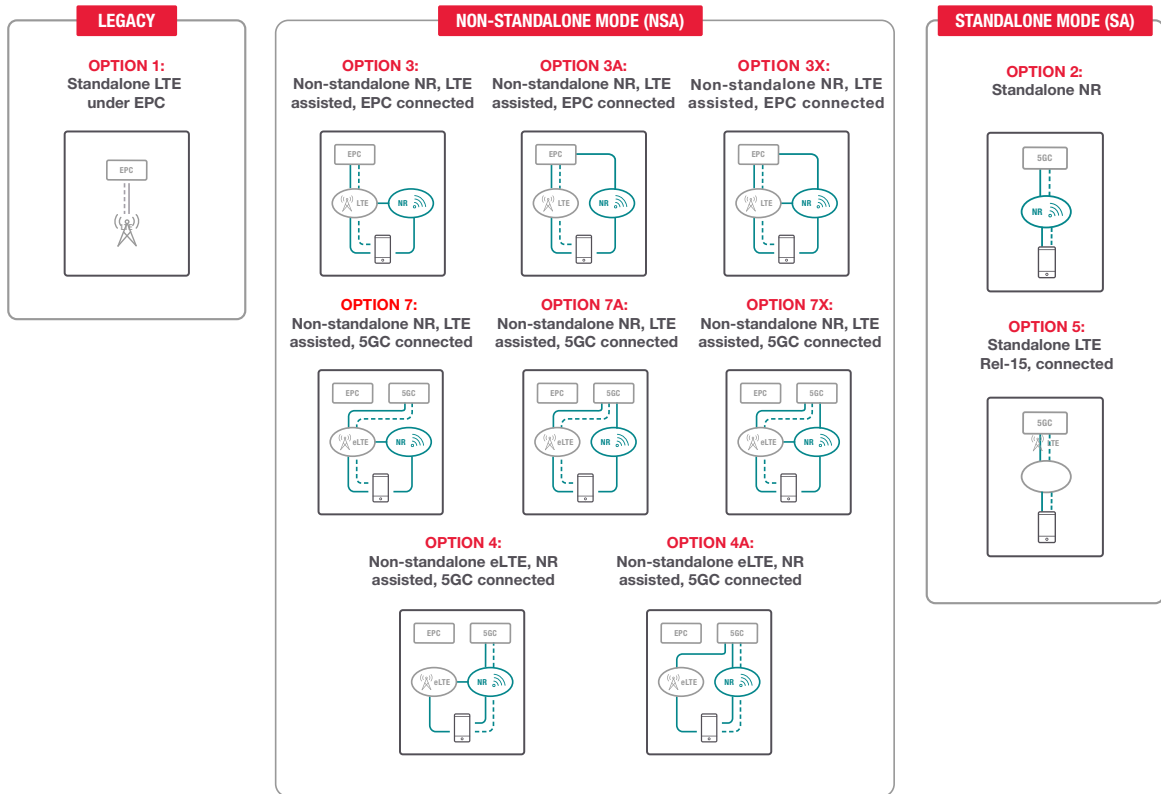
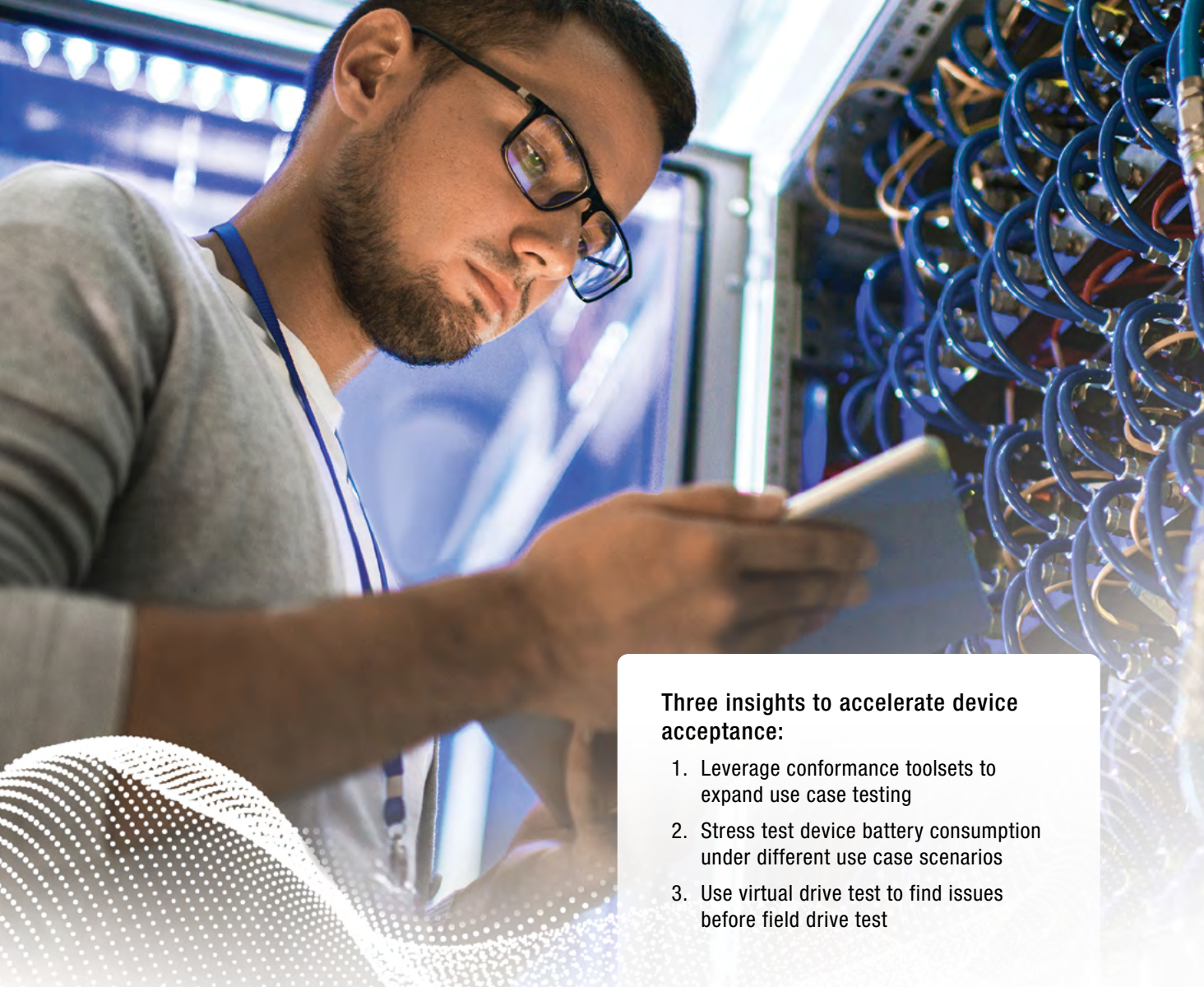

Figure 9.2. 5G NR deployment options

A common hardware platform that scales across frequency ranges and UE conformance tests — including RF, RRM, and protocol — provides the scalability needed to maximize 5G test case validation coverage. For example, the Keysight UXM 5G wireless test platform uses the same base hardware and spans protocol and RF/RRM conformance tests by using different software toolsets. The test platform is also scalable to wider bandwidths and higher frequencies with additional hardware.



Three insights to accelerate device acceptance:

1. Leverage conformance toolsets to expand use case testing
2. Stress test device battery consumption under different use case scenarios
3. Use virtual drive test to find issues before field drive test

Chapter 10 **Succeeding at 5G NR Carrier Acceptance**

In wireless communications, acceptance testing ensures a device will meet the KPIs on a specific mobile network. Consumer expectations are high with 5G NR, and consumers typically blame the mobile network operator for any issues they experience. If a device causes dropped calls or crashes a network, the operator gets the blame. Therefore, network operators stress test devices on their networks to ensure that they will live up to consumer expectations.

The operators serve as gatekeepers to what their networks support. They create performance and quality metrics as entry qualifications to their network. An operator acceptance test verifies whether the device has adequate performance and security functions for the specific network. The acceptance test also helps to identify and resolve issues before a device gets into the hands of a customer.

The introduction of 4G LTE represented a significant improvement over 3G. Now, 5G requires technical advances in the physical layer to provide greater flexibility and scalability in support of many new use cases. Also, massive MIMO and mmWave beam steering represent major changes in how 5G NR devices connect across sub-6 GHz and mmWave operating bands. It is critical to validate device quality of experience (QoE) and performance on the network given these changes.

The 5G NR vision of widespread connectivity, ultra-fast downloads, and low-latency, high-reliability connections — as well as the addition of mmWave operating bands — requires testing a large matrix of use cases. Operators also create test plans that include performance and functional tests. These tests cover more than the requirements for conformance testing. The tests focus on specific features/functions for the operator's network. It is important to understand each operator's priorities, so you can focus on the aspects that matter most to them and avoid wasting time on features that receive little attention. Whether you go through a formal device acceptance program or complement your current test plan, you need strategies to shorten your device acceptance phase and achieve better QoE and performance.

Due to the complexity and possible confidentiality of operators' acceptance tests, device vendors may find it difficult to perform acceptance tests ahead of time. However, there are strategies device vendors can use to test for the most likely use case scenarios in order to increase the likelihood of passing. Using the following insights, you can accelerate device acceptance and deliver better QoE and performance on an operator's network.



1. Leverage Conformance Test Toolsets to Expand Use Case Testing

Device conformance tests consist of RF characteristics, performance, RRM, and protocol. Generic test suites represent the most likely network configurations. These test configurations are sufficient for some use cases, but not all. Network operators have specific configurations or use cases to test that are important for their network. For example, for LTE, a conformance test configuration used 10 MHz channel bandwidth, but some operators deployed 20 MHz channel bandwidth. In this case, operators performed additional testing to ensure quality and performance with 20 MHz bandwidth.

Network emulation allows you to test devices under many different use scenarios in a lab environment. A flexible conformance test solution provides a network emulation platform along with the test cases specified in the 3GPP standards. You may use conformance test solutions for operator acceptance tests if the conformance toolset allows customization of test cases beyond the certification requirements with additional test equipment. For example, adding a power analyzer enables testing battery performance, and extending the test equipment frequency range enables testing of different frequency band combinations or testing for other potential interfering signals.

“Xiaomi is committed to delivering cutting-edge R&D innovation and technology. Leveraging Keysight's 5G network emulation solutions will enable us to greatly accelerate development of our 5G mobile devices and establish a leadership position in the industry.”

Zhang Lei
Senior Director of Xiaomi Corp.

There are years of expertise built into conformance toolsets that will make acceptance testing easier. At Keysight, for example, we work with leading chipset and device manufacturers to test and ensure their designs perform to the new standards and meet consumer expectations. Much of this work happens before standards completion and is updated as the standards evolve. By working from the same platform in early R&D through design validation and into conformance and device acceptance testing, continuity and expertise are embedded into the platform and across the device workflow, accelerating time to market.

It is important to select a test platform that incorporates regular software updates that include newly validated test cases to ensure testing against the latest standards. It is also beneficial to choose a platform that can cover 4G and 5G, as well as range from sub-6 GHz to mmWave frequencies, resulting in a more flexible solution that can cover the necessary test scenarios.

2. Stress Test Device Battery Consumption Under Different Use Case Scenarios

Manufacturers continue to add more features and functions to smartphones that consume more battery life. Also, with the use of mmWave operating bands and 4G LTE/5G NR dual connectivity, device power is critical to establish and maintain a quality communications link with 4G and 5G NR base stations. 5G NR use cases vary widely, impacting battery requirements and performance. eMBB, for example, focuses on high data throughput, requiring higher processing power that quickly drains the device battery. By contrast, mMTC requires the support of small data packets transmitting over very long timeframes.

Battery life is a key metric that influences the consumer's perception of product quality. A device manufacturer that can produce a device that operates longer between charges and under many different usage scenarios can gain a significant competitive advantage. Battery consumption tests require testing when connected to a network, and under the different usage scenarios expected in 5G.

5G devices need to handle multiple complex tasks. Battery performance tests need to evaluate battery life in real-world situations under different usage scenarios. Network operators develop their own tests and focus on specific customer profiles based on the services and features they plan to offer on their network. Figure 10.1 shows an example of battery consumption under different usage scenarios. Battery performance under different usage scenarios of data consumption, talk time, or with the use of location-based services is a common test. As a device manufacturer, you can select key representative use cases that you anticipate on the mobile network and stress the device to ensure battery life with many different permutations and combinations of activities.

With a network emulator and power analyzer, you can test many different battery scenarios by simulating 4G/5G radio access networks and evaluating power consumption under real-world conditions.

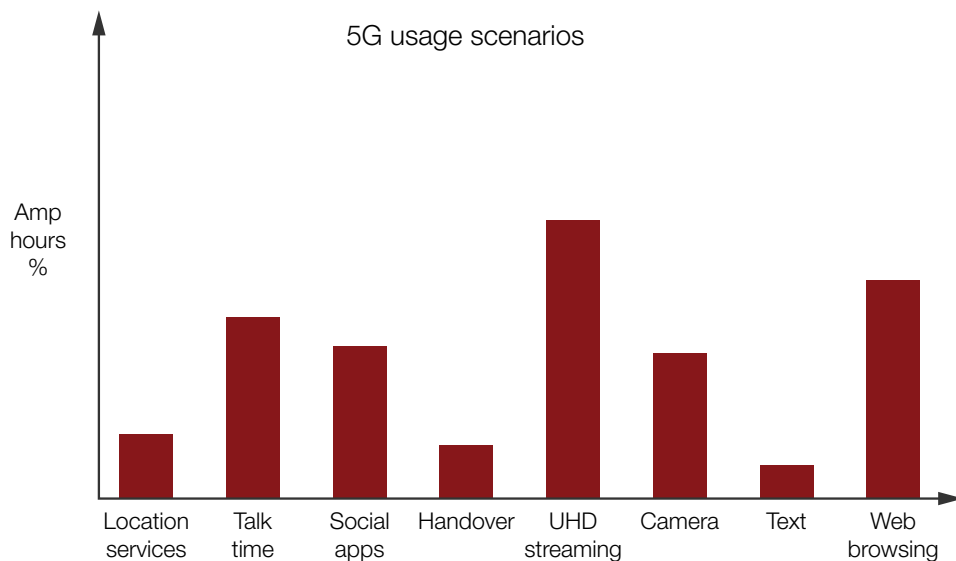

Figure 10.1. Battery consumption under different usage scenarios

3. Use Virtual Drive Test to Find Issues Before Field Drive Tests

LTE relied heavily on the existing 2G/3G infrastructure to provide coverage until the full development of 4G. As a result, devices required testing to ensure seamless handovers from one LTE cell to another, as well as handovers from 4G LTE to 2G/3G cells. Also, devices needed to switch between data and voice without losing the connection. While it was important for 4G to test for handovers between different RATs under different channel conditions, it is even more critical for 5G NR because of new initial access procedures.

In 5G NR NSA, 5G devices operate alongside and with the 4G infrastructure. While the 5G NR conformance requirements test for handovers, switching, and fallback to 4G cell sites, these tests are not sufficient to determine the user's experience during different field conditions or for covering all operator-specific handover scenarios. Therefore, it is necessary to evaluate real-world handovers between radio networks.

These types of tests are typically performed in the field using a drive test. However, field drive tests are costly when you consider the number of hours required to test the many different scenarios in all geographic locations. Imagine sending resources out on the road to conduct these tests in all parts of the U.S., Europe, or China. The field tests can take many months, if not years, to complete.

While testing a device under simulated conditions in a lab enables testing of the basic operation, operators also need to understand how the devices will behave with different signal propagation issues like path loss, multi-path fading, and delay spread. They also need to know how the device reacts if something goes wrong.

Using virtual drive testing, device makers test the real-world handover performance of their device before deployment in a live network. Virtual drive test uses data captured in the field to build tests that replay drive or indoor test routes by emulating real-world RF network conditions, including network signaling, cell settings, and RF in a controlled laboratory environment. A real network infrastructure or a simulated network using a network emulator can replay the network conditions. Virtual drive testing shown in Figure 10.2 enables real-world mobility scenario testing in a lab environment. You can do fault analysis and performance optimization to provide better QoE by applying different test case and channel scenarios to identify potential issues before the completion of an official drive test.

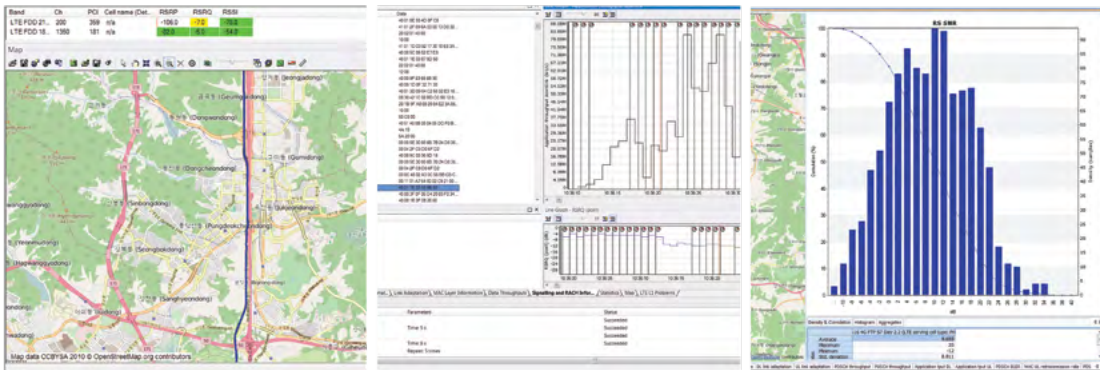
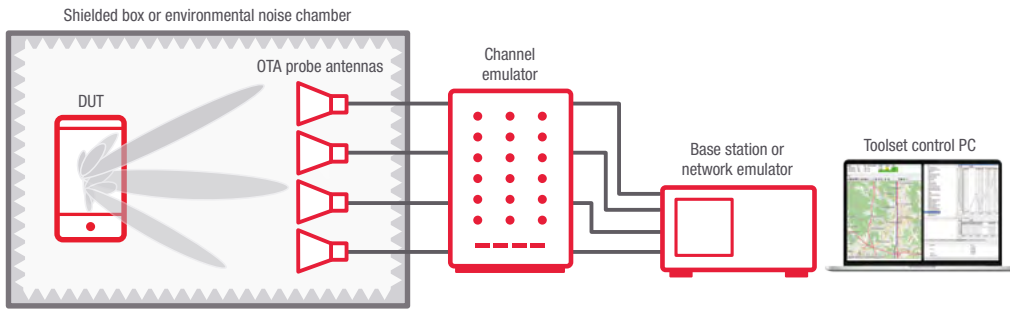

Figure 10.2. Use virtual drive test to assess true performance and interoperability of networks in the laboratory

A virtual drive test is a proven test technique. Mobile network operators used this technique to assess the performance of 4G devices in network vendor interoperability testing (NV IOT) labs and for testing device performance verification in high-speed train scenarios.



Four insights to accelerate time to market:

1. Achieve production goals with multi-DUT testing
2. Eliminate delays with common measurement science
3. Maximize throughput with high-performance instrumentation
4. Address rapidly rising demand with financial services

Chapter 11 **Preparing for 5G NR High-Volume Manufacturing**

High-volume 5G device manufacturing is imminent. Increasing throughput while controlling the cost of test will be the top priority. In the context of 5G, added pressure comes from accelerating timelines and the high technical complexity.

The industry needs to take 5G through the manufacturing workflow from new product introduction (NPI) to high-volume manufacturing (HVM) as fast as possible. 5G introduces significant disruption in the mobile communications industry, though, with a shift to mmWave frequencies, wider bandwidths, and OTA test methods.

mmWave radiated testing is entirely new to cellular manufacturing. Switch matrices and long cables incur high losses. Air absorption, high insertion loss, and fragile and expensive connectors reduce dynamic range and impact measurement quality. It is imperative to accurately compensate for path loss with system calibration and decreasing the distance between the DUT and the OTA chamber.

Devices need to support both legacy bands and new frequency bands, increasing design complexity and test times. Greater bandwidths and new frequency bands drive higher test costs, as do an increase in the number of test points and more stringent requirements for EVM, flatness, and dynamic range.

Disruption provides the opportunity for market challengers to displace incumbents. Device manufacturers must master the complexities of 5G, innovate, and accelerate their time to market to win the 5G race. In the manufacturing cycle of the device workflow, new strategies are necessary to meet ever-challenging goals and tighter schedules.

Use the following insights to accelerate your time to market and reduce the cost of test.

1. Achieve Production Goals with Multi-DUT Testing

Testing multiple devices at the same time is critical to increase production capacity and reduce the cost of test. Device makers can use parallel device testing to push the concept to its limits by using instrumentation designed with multi-device testing in mind.

5G represents a brand-new way of thinking about high-volume device manufacturing for 5G mmWave devices. Simultaneously testing multiple 5G mmWave devices requires radio heads and chambers for each DUT, as well as higher real estate costs and capital equipment costs. The production capacity of device makers is limited to the real estate they have with contract manufacturers that typically charge by the square foot. Device makers are at a crossroads between higher real estate costs and lower production capacity. They can overcome this challenge by adopting innovative multi-DUT testing solutions that minimize floor space. For example, with Keysight's EXM wireless test set, device manufacturers can test four 5G DUTs in FR2 at once using four transceiver (TRX) modules. Refer to Figure 11.1.

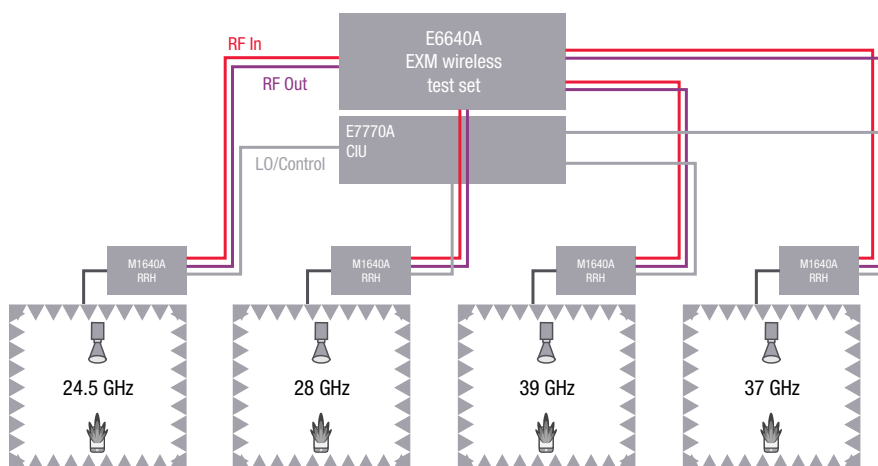

Figure 11.1. 4-port mmWave 5G solution testing four DUTs simultaneously for four different 3GPP-specified operating bands

Remote radio heads (RRHs) provide scalability, enabling the solution to work against a wide range of mmWave frequencies (FR2) while adding configurability to the test environment. RRHs' physical placement close to the measurement probe reduces cable loss. However, when test engineers switch them out manually on the manufacturing line, RRHs can introduce errors and generate calibration issues. To avoid these issues, some device manufacturers have opted to dedicate wireless test sets to different bands. With the Keysight solution, device manufacturers do not have to sacrifice flexibility because the same RRH covers all 3GPP-specified bands.

2. Eliminate Delays with Common Measurement Science

Device makers face tremendous technology evolution with 5G because of wider bandwidths and mmWave frequencies. At the same time, they are under extreme cost and time pressure to win the 5G race. Many device makers adopt a silo approach to device development and test, with dedicated test teams for each phase. Each team typically selects test equipment best-suited for their phase of the workflow, which leads to measurement correlation issues. Such issues often occur when transitioning from R&D to manufacturing. Migrating the test intellectual property (IP) can add three to six months of delay, and correlation problems affect yield.

Many device makers overlook the time-to-market efficiencies they could gain by adopting a common measurement science across the device workflow. They need instruments that work across each phase of the device workflow that also minimize test IP migration efforts to ensure measurement correlation. Keysight PathWave facilitates the transfer of IP from DVT to manufacturing. Keysight's UXM and EXM test solutions use the same hardware components, common interface unit (CIU), and RRHs. Teams across the device workflow are familiar with the same test equipment, and common measurement science makes the transition of IP easier. RRHs used in R&D and manufacturing perform similarly. Additionally, the various equipment types make measurements such as EVM the same way. Consistency in measurements reduces the chance of errors and accelerates time to market.

3. Maximize Throughput with High-Performance Instrumentation

Testing each device faster is another strategy device makers can use to accelerate the testing process and increase their production output while reducing the cost of test. Instrumentation featuring quad-core controllers and leveraging a high-speed PXIe backplane provides ultra-fast data processing.

In addition to raw hardware speed, advanced sequencing techniques and single-acquisition multiple measurements can help to maximize throughput by accelerating test execution. Sequencing capability is essential for device makers because of the sheer number of 5G devices that require production as fast as possible. They allow device makers to select the most efficient sequence for their DUT.

First pass yield (FPY) is a critical metric for device makers, and even more so in the context of 5G. With the complexity of 5G, FPY could likely drop. The top smartphone manufacturers will need to deliver tens of millions of phones on an annual basis by 2023. They are potentially looking at significant rework or scraps with 5G. Instrumentation with superior signal purity and measurement accuracy can increase FPY.

The EVM performance and absolute level accuracy of the instrumentation used to make the measurements is critical for optimizing FPY. 5G mmWave also drives a shift from conducted to radiated test methods. The integration of test equipment with OTA chambers is essential to ensure reliable measurements.

4. Address Rapidly Rising Demand with Financial Services

Device makers are under pressure to deliver their products in volume and on time, and sharp increases in production volume present a significant challenge. As standards continue to evolve, production planning must account for a wide range of order quantities since 5G devices are complex due to the various use cases. The manufacturing operations of device makers must be dynamic and responsive to demand and technology trends.

Device manufacturers need to adjust test capacity quickly and easily and modify their manufacturing test operations to meet volume goals and target dates while conserving capital. The competitive nature of the 5G device market also demands that manufacturers maximize their operational and capital budgets to produce 5G devices. OpEx can help address that need. While OpEx budgets cannot be used to purchase new test assets, they can fund operating leases. Leases provide instant access to leading technologies with a lower impact on budgets.

Leases are not necessarily short-term contracts. They can also provide long-term use of needed test assets and generate significant cost savings compared to purchased equipment. For 5G, they also offer the added flexibility device manufacturers need to keep up with the evolution of the technology, as evolving standards require new, different, or upgraded equipment.

It is critical to maximize production line uptime as device makers face significant competitive pressure. Production delays can have a dire impact on market share. Deploying robust equipment designed for the production floor is essential.



Company: 5G NR device manufacturer

Key Issue: Expanding test capacity while staying within capital expense limits and ensuring flexibility

Solution: Scalable, OpEx funded access to test assets through Keysight Financial Services

Results:

1. Six months faster time to market
2. Immediate access to test assets with an operating lease, providing 42% savings vs. a CapEx purchase
3. Added flexibility to exchange leased assets for different or updated instruments as 5G standards evolve

Chapter 12 How to Double Test Capacity with Zero Additional CapEx

The creation of 5G cellular mobile communications is a massive and complex endeavor involving companies around the world, ranging from chipmakers and device developers to network equipment manufacturers and network operators. During regional field trials, chipmakers and device manufacturers strive to win contracts and deliver their products in volume and on time. Orders come in quickly if early tests prove successful, and an operator decides to expand its field trials.

The possibility of a sharp increase in production volume injects uncertainty into the manufacturing process. Production planning must account for a wide range of potential order quantities. The manufacturer must be able to quickly and easily adjust test capacity to meet volume goals and target dates.

A leading company in the wireless ecosystem faced this problem as it moved forward with a new 5G NR product. Its test stations ran all day, every day, but it could not keep up with rapidly rising demand. Keysight introduced the company's manufacturing team to a leasing program that enabled greater flexibility without tapping into CapEx budgets.

The Challenge: Double Test Capacity without Tapping CapEx



Figure 12.1. The highly integrated UXM wireless test set is designed for functional testing and design validation

The company had pushed its resources to the limit, racing to be first to market with new products that supported 5G NR. To maximize product testing, it had been running eight Keysight E7515A UXM wireless test sets (Figure 12.1) 24 hours a day, seven days a week. Volume grew rapidly, but to meet contracted production goals, the company would need to double its test capacity as soon as possible.

The primary challenge was financial. With the end of the fiscal year rapidly approaching, the department had no budget remaining for capital equipment purchases. As a result, it would not be possible to fund a purchase of eight new UXM test sets before the end of the fiscal year.

The Solution: Fund an Operating Lease with OpEx

Desperate for expanded test capacity, the company reached out to its local Keysight team. Talking through the issues led to an important discovery — even though CapEx reserves were depleted, the OpEx budget was underspent. Although the available OpEx balance could not be used to purchase new test sets, it would fund an operating lease through Keysight Financial Services.

The Results: 42% Savings and 6 Months Faster Time to Market

In this case, the operating lease enabled long-term use of the needed test assets at a much lower cost than making an outright purchase. With an 18-month operating lease, the customer gained access to \$8 million in instruments for an OpEx expenditure of \$4.7 million.

The results: a 42% savings and immediate access to the test equipment. The operating lease also accelerated the company's internal purchasing process by avoiding a CapEx approval process. Overall, the customer saved six months in time to market.

This approach provides flexibility to renew the lease inexpensively if evolving 5G standards require new, different, or upgraded equipment. Through the renewal process, customers can return unneeded or outdated equipment, access new solutions, or continue with low lease payments.

Chapter 13

Solutions that Accelerate 5G Innovation

New spectrum and technologies introduced with 5G NR require you to think differently about how you design and test devices. Consistent results enable teams to leverage measurements and get to market faster. Keysight solutions leverage the same measurement techniques throughout the workflow to ensure consistent results, guiding you to the appropriate test cases specified by chipset vendors and operators.

Keysight's PathWave design and test software platform accelerates product development workflows from concept to design, through manufacturing test, via an integrated software platform that connects every step in your product development path. PathWave's open and flexible development environment provides a consistent user experience, common data formats, open control interfaces, and open APIs. With PathWave, you have an open, scalable, and predictive platform that can accelerate your design and test workflow.



Components & RFIC Solutions

Circuit design & simulation software solutions

Keysight's design and simulation solutions integrate 5G NR waveform generation and analysis with simulation. This integration enables advanced system-level modeling so you can fully characterize components before developing hardware.

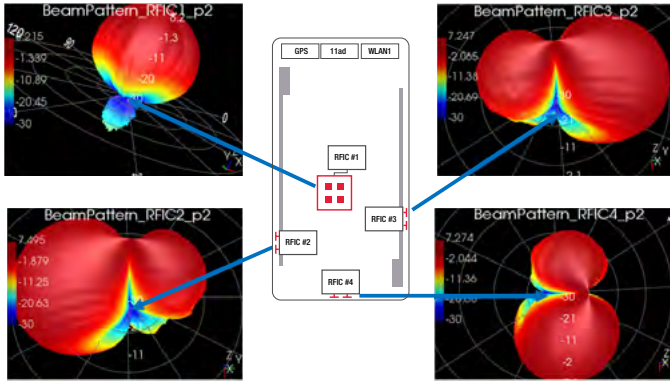

PathWave System Design (SystemVue)

PathWave System Design 5G NR libraries

Keysight PathWave System Design (SystemVue) electronic design automation software is used to model and simulate system designs early in the development process. It enables physical layer design of wireless communications systems and provides unique value to RF, digital signal processing, field-programmable gate array (FPGA)/application-specific integrated circuit (ASIC), and MIMO implementers.

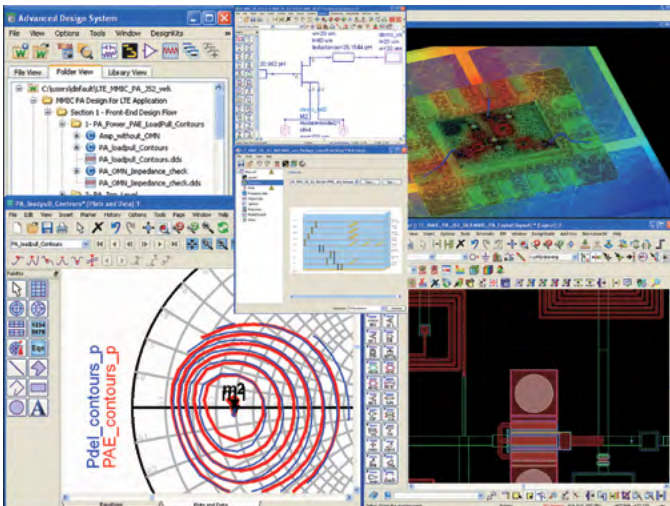

PathWave ADS

PathWave Advanced Design System

PathWave Advanced Design System (ADS) electronic design automation software for RF, microwave, and high-speed digital applications offers technologies such as X-parameters and 3D electromagnetic (EM) simulators for standards-based design and verification in an integrated platform. The W2383EP 5G Modem Library for ADS enables design and verification for emerging 5G wireless standards.

Baseband development solutions

Keysight's multichannel arbitrary waveform generators (AWGs) can create baseband IQ signals with extremely wide RF/microwave signals from DC to 25 GHz using Keysight's PathWave Signal Generation (Signal Studio) for 5G NR Software. Keysight AWGs provide reliable and repeatable high-fidelity signals, delivering both high resolution and wide bandwidth simultaneously. Keysight's digitizers provide multiple phase-coherent channels for evaluating MIMO or multiple baseband IQ channels using the Keysight PathWave 89600 VSA Software with 5 NR Modulation Analysis (Option BHN).



Wideband Arbitrary Waveform Generators



Wideband Digitizers

RF development solutions

Keysight's portfolio of RF development solutions enable you to evaluate and characterize your designs into mmWave frequencies, with wide bandwidth and the fidelity needed to achieve 5G design goals at different stages of RF design.



5G R&D Test Bed



Wideband RF/mmWave Signal Creation

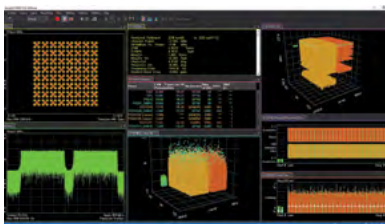

Wideband RF/mmWave Signal Analysis



Infiniium Oscilloscopes

High-Speed Digital Interface Solutions

PathWave ADS signal integrity and power integrity software

PathWave Advanced Design System (ADS) Signal Integrity (SI) and Power Integrity (PI) tools leverage time and frequency domain simulation and analysis to quickly solve the underlying problems with high-speed digital designs. The integrated schematic capture, layout, and data analysis environment with multiple simulators including IBIS-AMI channel, transient, S-parameters, and physical layer EM ensure compliant designs with the latest standards.

MIPI® verification

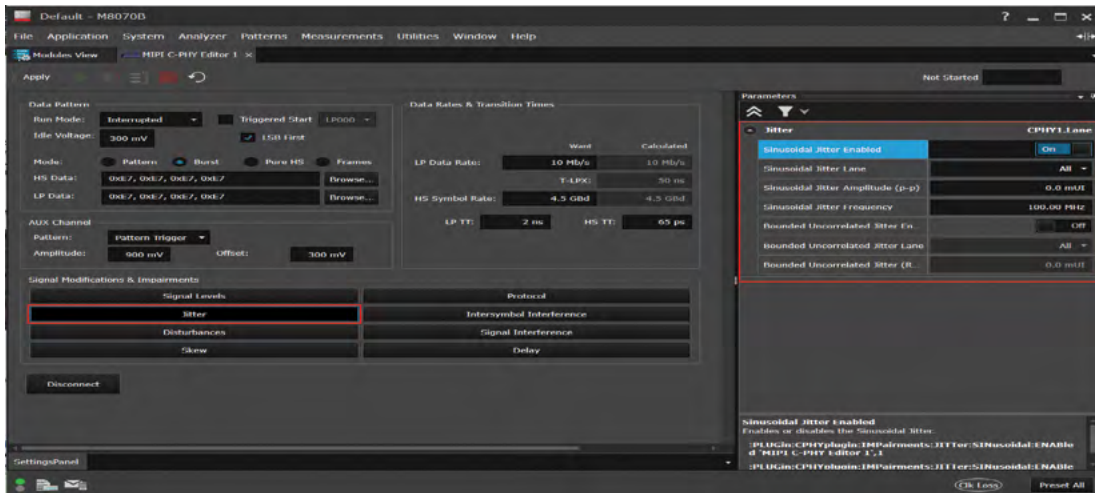

MIPI® Receiver Test Solution

The M8000 Series multi-channel bit error ratio test (BERT) solutions enable physical layer characterization, validation, and compliance testing of digital interfaces. M8085A MIPI Receiver Test Solution is a software plug-in that adds controls for the M8190A/M8195A arbitrary waveform generators to create C-PHY or D-PHY standard-compliant test signals.

“Keysight has enabled us to validate the breakthrough data throughput performance of our Ball-built arrays at 26 GHz and gain visibility into our performance edges, using standard-compliant 5G NR waveforms and processing.”

Bob Donahue
Chief Executive Officer, Anokiwave

MIPI® is a registered trademark owned by MIPI Alliance

5G channel emulation solution



PROPSIM F64 5G Channel Emulator

“Powered by the leading test solutions from Keysight, Spreadtrum can accelerate the R&D process of 5G chipsets, and strengthen our 5G global deployment.”

Adam Zeng,
Global Executive Vice President of Unigroup
and Chief Executive Officer of Unigroup
Spreadtrum & RDA

Battery optimization solution

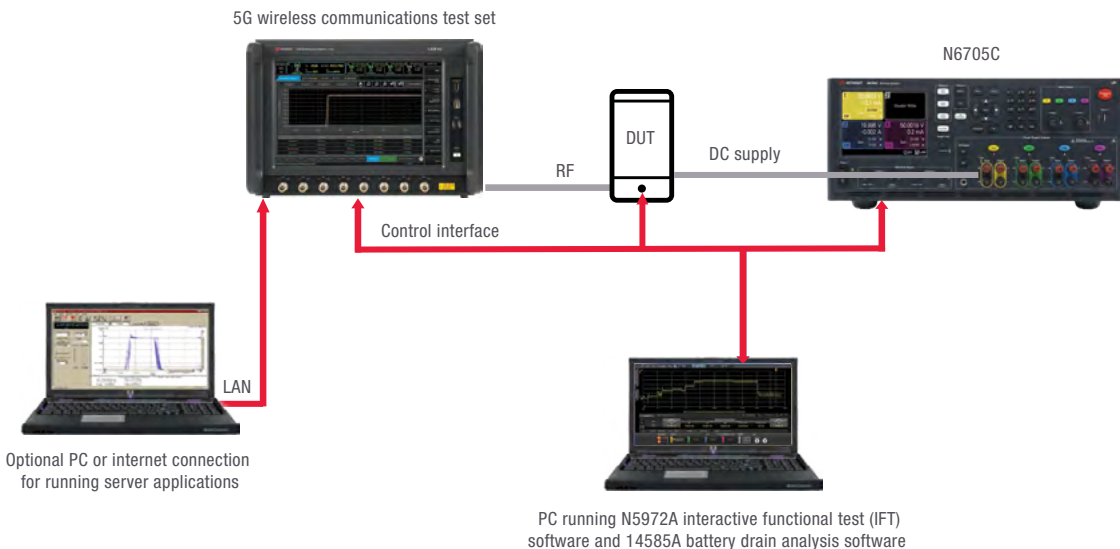

Battery Drain Test Solution

OTA Test Solutions

Keysight offers a portfolio of OTA solutions for sub-6 GHz and mmWave frequencies. A typical solution consists of measurement hardware and software, a network emulator to emulate the 5G gNB, and a channel emulator to emulate the radio conditions. RF enclosures, probe and link antennas, different DUT positioners, and associated control software are used to complete the OTA test. Together, our offering addresses the different test approaches and the varying needs across the workflow, from R&D to device acceptance test.

Manufacturing Test Solutions

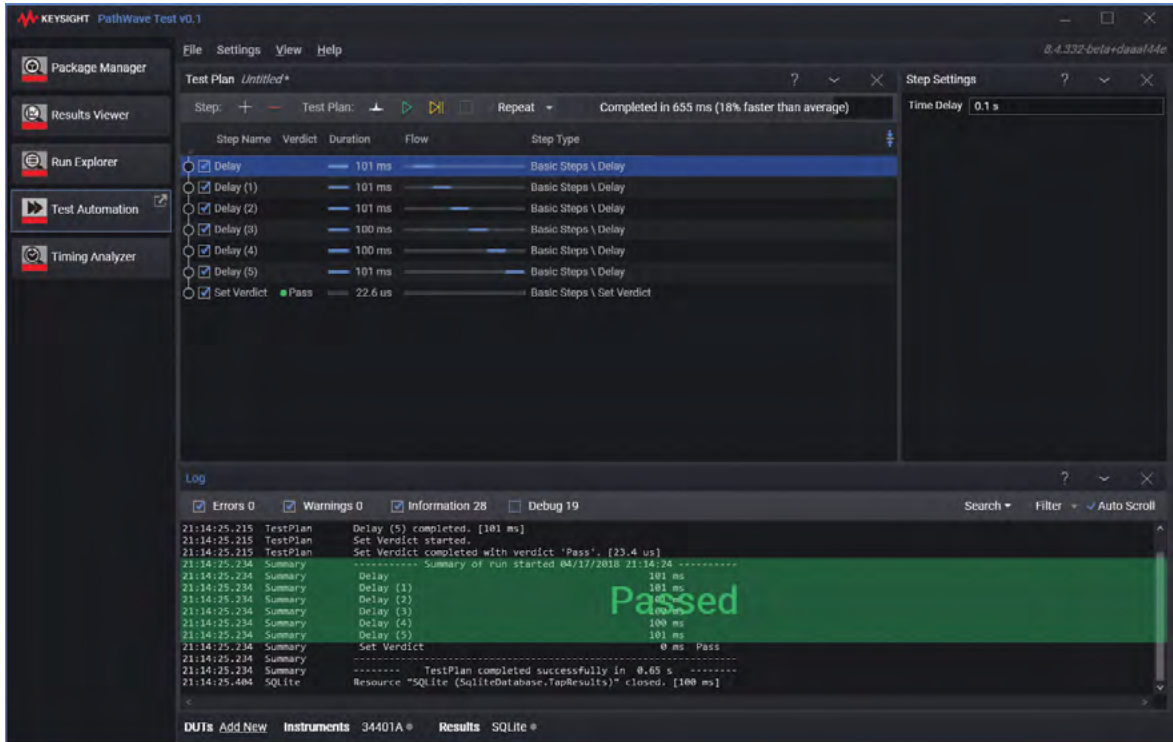

KS8700A PathWave Test Automation



5G Non-Signaling mmWave Test Solution



EXM 5G Multi-device Test Solution

“Keysight and Qualcomm worked together to demonstrate multi-Gigabit 5G data connection at Mobile World Congress. As we did in 3G and 4G, Qualcomm Technologies’ mobile expertise was fundamental in achieving this 5G milestone in a 5G smartphone form factor. Our combined technical competency enabled both teams to overcome challenges as we work towards the commercial launch of 5G mobile devices expected in 2019.”

Tony Schwarz

Senior Vice President, Engineering,
Qualcomm Technologies, Inc.

“We are delighted to collaborate with Keysight. Their leading test and measurement expertise and solutions for 5G will enable us to execute on our commercial deployment plans more efficiently and reliably.”

Jeon Hongbeam

Executive Vice President, Infrastructure Laboratory
Institute of Convergence Technology at KT Corporation

Section 4

Speeding Time to Market for 5G Base Stations and Components



“Our future depends on our ability to innovate new products at competitive prices. (...) Keysight helped us to innovate a new approach to testing. They really understood the problem and helped us design a solution, so we can transform and win in our market.”

Design and Test Director
Worldwide Original Equipment Manufacturer (OEM)
Radio Equipment for 4G and 5G Networks

Chapter 14

5G Equipment Challenges

The launch of 5G chipsets in 2018 started the 5G race, and it continues today. New types of deployments are emerging to capture the revenue from novel business models. Standards continue to evolve. 5G NR emerged in 2017 with the approval of the NSA version. The SA version and other releases followed in 2018. Release 16 will add the necessary capabilities for V2X and IIoT applications, unlicensed bands, and high frequencies.

Technical complexity is high. NEMs need to integrate complex multichannel antennas covering many frequency bands. Other objectives include lower latency and support for a broad range of machine and user behaviors in base stations.

Engineers working on components also face significant technical challenges. MIMO antennas, for example, require multiple transmission and reflection measurements for each antenna element.

As you can see, 5G introduces disruptive changes to NEMs and component manufacturers across the entire workflow, from R&D and quality assurance (QA) to manufacturing. Engineers struggle to design high-performance 5G base stations. They need to create innovative ways to implement the physical layer in communications systems.

At the same time, they need to verify that their designs comply with the latest 5G standards and meet the high expectations of enterprises and consumers. Thorough functional and performance testing spanning RAN and core aspects — as well as testing with real-world conditions — are essential to passing conformance tests.

In manufacturing, accelerating time to market while reducing the cost of test are competing priorities. NEMs need to ensure a smooth transition from QA to volume manufacturing by deploying innovative test strategies. Addressing the challenges of mmWave frequencies and OTA testing is critical.

To win the 5G race, component manufacturers need greater confidence that comes from measurement integrity. They also need to accelerate time to market and reduce test costs to stay competitive. The high throughput of true multiport test setups gives component manufacturers the performance they need to keep up with aggressive timelines.

The solution is to adopt design and test solutions that span the entire workflow, including design automation, development, and design verification, as well as conformance and manufacturing test. Keysight's end-to-end coverage generates new insights that accelerate 5G innovation across the workflow. Figure 14.1 summarizes the 5G base station and component workflows.

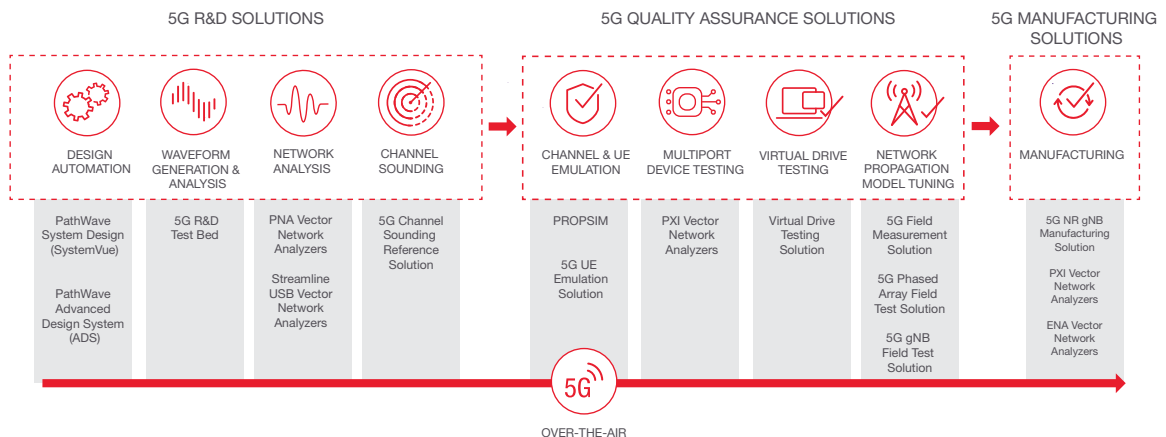

Figure 14.1. 5G stages for a successful product

A Common Theme: Leverage Work Done Earlier in the Workflow

NEMs and component manufacturers must modify their manufacturing test strategies to leverage the work done, and data gathered, at each stage of the design-to-manufacturing workflow. Optimizing the transition from conformance to manufacturing is crucial to profitability, volume production, and time to market for NEMs. Using the same measurement algorithms across the workflow helps reduce development time by giving engineers higher confidence in their measurement results. Traceability back to design accelerates resolution when issues do occur.

Protocol testing is a challenge of the past in the manufacturing environment. Non-signaling testing eliminates costly signaling overhead and increases throughput while maintaining test integrity. Adopting common test platform elements is essential for moving network equipment through the workflow quickly. It also helps with controlling the cost of test for globalized operations.

Using common elements across test platforms is also essential to accelerate time to market for components. Component manufacturers typically use different platforms across the workflow, from R&D to design validation to manufacturing. They also use different form factors in each phase of the workflow for different purposes. A common user interface across platforms helps minimize learning time.

For network analysis, key performance metrics — dynamic range, measurement speed, trace noise, and temperature stability — matter above all others. These specifications enable component manufacturers to measure their devices more accurately or faster. Leveraging hardware across form factors yields similar levels of performance on key specifications by enabling component manufacturers to achieve consistent measurement results. Keysight's M980xA Series of PXI vector network analyzers (VNAs), P500xA and P502xA Series of USB VNAs, and the E5080B benchtop VNAs, for example, use the same hardware and deliver the same overall performance.

“Keysight’s end-to-end 5G test solutions have accelerated the development and validation of our new 5G designs across the workflow, from early prototyping to design validation and manufacturing.”

Woonhaing Hur
Vice president of System LSI Protocol Development
at Samsung Electronic

A common firmware architecture is also important to enable common software assets across platforms. Component manufacturers that adopt instruments that use the same firmware can easily increase the software coverage of their instruments. They have at their fingertips more measurements — pulsed RF, spectrum analysis, noise figure, gain compression, mixer/converter measurements — enabling them to measure a broad range of devices. For common features, they can also leverage software developed in R&D, if they adopt instrumentation that features the same firmware.



Chapter 15 Accelerating 5G NR MIMO Designs

Enabling technologies such as MIMO and beamforming are critical for 5G. Engineers will use active phased array antennas to implement MIMO and beamforming in base stations and devices. These active antennas are essential to overcome signal propagation issues, such as higher path loss at mmWave frequencies. They also provide the ability to dynamically shape and steer beams to specific users.

Active antennas offer more flexibility and improve the performance of 5G communications, especially at mmWave frequencies. Deploying active phased array antennas in commercial wireless communications represents a major change from the passive antennas used in previous generations. MIMO and beamforming technologies increase capacity and coverage in a cell. For 5G devices and base stations, multi-antenna techniques require support across multiple frequency bands — from sub-6 GHz to mmWave frequencies — and across many scenarios, including massive IoT connections and extreme data throughput.

Implement 5G NR multi-element active antennas successfully by:

1. Accommodating for greater mmWave frequency path loss
2. Verifying the RF performance of 3D antenna beam patterns OTA
3. Optimizing base station performance under real-world conditions

Designers must overcome many new challenges while implementing MIMO and beamforming on 5G base stations. They need to carefully select hardware and software tools to simulate, design, and test highly complex systems containing tens or even hundreds of antenna elements.

Aerospace and defense radar and satellite communications use active phased array antennas. These antenna arrays are typically very large and expensive, and applying this technology to commercial wireless introduces new challenges. For example, there is a long list of 3GPP required tests for base stations, including radiated transmitter tests and radiated receiver tests. Depending on the base station configuration, some FR1 tests require radiated tests, and all FR2 tests require radiated tests.

Access the 3GPP TS 38.141-1 and -2 documents to understand measurement uncertainties, test methods, test procedures, and test requirements.

With the use of higher frequencies, wider bandwidths, and multi-element active antennas, base station conformance tests are significantly different and more challenging than previous LTE tests. The use of active antenna arrays in 5G NR requires innovation in antenna designs, and new ways to test in design characterization, pre-conformance, and conformance testing. Accelerate your designs and get your products to market faster with the following insights.

1. Accommodate Greater mmWave Frequency Path Loss

Increased path loss and signal impairments are more problematic at mmWave frequencies. Issues with mmWave signal propagation greatly reduce the distances of the signal's effectiveness. Therefore, base stations will use hundreds of antenna elements to create high-gain directional antennas.

Test solutions for mmWave products need to accommodate higher frequencies with wider channel bandwidths, as well as address the increased path loss at mmWave frequencies. A test solution must have adequate signal to noise ratio (SNR) to detect and demodulate 5G signals accurately. When testing transmitters, SNR is critical in the test analyzer to make accurate EVM and ACLR measurements. Choosing a signal analyzer with greater dynamic range will help overcome SNR issues.

It is important to use VSGs with high output power and low EVM to improve SNR and ensure the receiver can detect and demodulate the signal. Also, system-level calibration is important to correct for system phase and magnitude shifts over the bandwidth of the measurement. Figure 15.1 illustrates how a corrected waveform will account for channel response at the DUT plane. A power meter/sensor, signal analyzer, or network analyzer that measures the frequency response is required. The measured data is then used in the signal generator to pre-correct the waveform over the entire bandwidth.

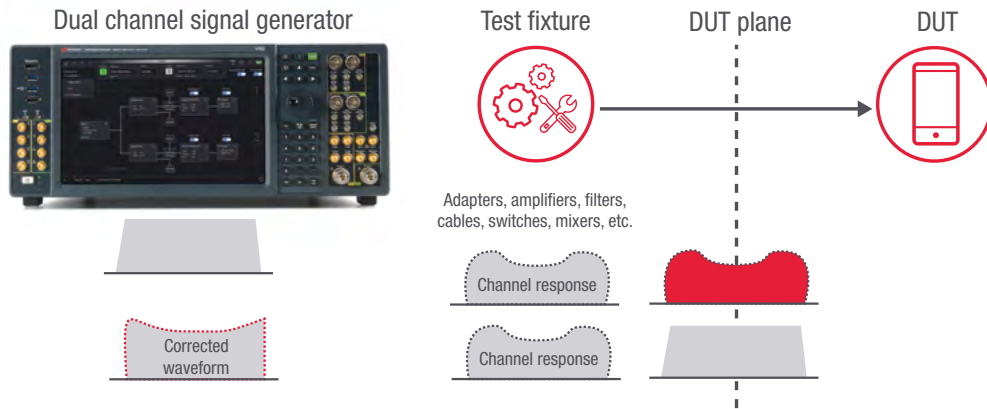

Figure 15.1. Applying system-level calibration to correct for channel response in receiver test

2. Verify the RF Performance of 3D Antenna Beam Patterns OTA

Most, if not all, 5G MIMO testing happens over-the-air. Early in development, OTA test solutions need to characterize the 3D beam performance across the range of the antenna, including aspects such as antenna gain, sidelobe, and null depth for the full range of 5G frequencies and bandwidths.

Radiated pre-conformance and conformance tests require a calibrated OTA test solution that covers all the requirements in the 3GPP TS 38.141 documents. For example, the following key tests are required:

- Radiated transmitter characteristic tests require effective isotropic radiated power (EIRP) OTA measurements to verify accurate generation and radiated power per beam across the frequency range.
- Modulation quality tests measure the difference between the measured carrier signal and a reference signal OTA, expressed as EVM.
- OOB measurements mean the test solution needs to cover up to the second harmonic — 60 GHz per the OTA specification today and increasing to more than 100 GHz in the future as new higher frequency operating bands are added to the specification.

Radiated receiver tests include measurements such as dynamic range, or selectivity and blocking, to test the receiver's ability to receive the desired signal at its assigned channel frequency in the presence of an adjacent interfering signal. This test setup requires multiple mmWave signal generators with high output power to overcome mmWave path losses.

OTA test systems at mmWave frequencies require test equipment to not only meet the frequency and bandwidth requirements but also have improved performance (better than the DUT) to evaluate the DUT RF performance properly.

3. Optimize Base Station Performance Under Real-World Conditions

5G needs to operate in higher frequencies, with wider channel bandwidths and using multi-element phased array MIMO access techniques. In these environments, there are signal propagation issues such as excessive path loss, multi-path fading, and delay spread that can impact system performance. Engineers need to take these impairments into account when they evaluate 5G designs to ensure efficient performance under real-world fading and interference channel conditions.

Performing these types of tests in the field requires several weeks — or even months — to evaluate different physical locations that require testing. Adding a channel emulator to the test setup in the lab accelerates the evaluation. It enables the characterization of the complete end-to-end performance with coherent real-world complex 3D propagation channels used in MIMO. Figure 15.2 shows a signal generator combined with a channel emulator to emulate real-world radio conditions in a lab environment. It also includes mmWave heads to minimize RF losses from the DUT to the RF test equipment. Such a test setup is useful to evaluate and optimize MIMO antenna performance for different channel conditions.

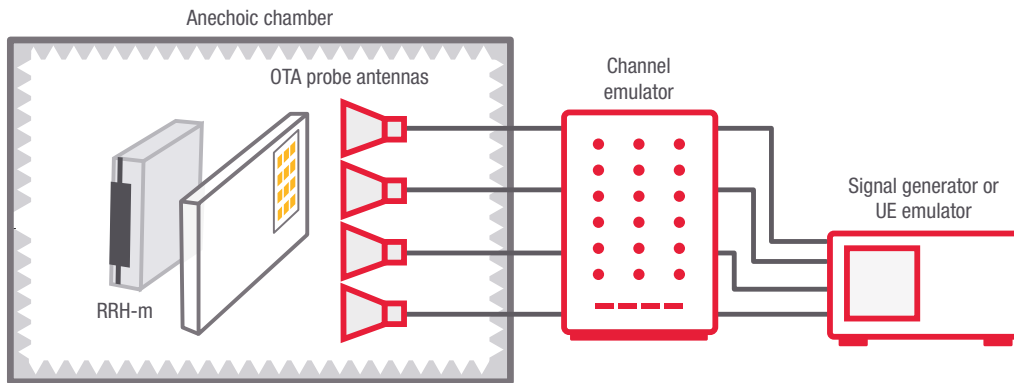

Figure 15.2. A signal generator/UE emulator, combined with a channel emulator, enables the evaluation and optimization of base station performance under real-world conditions



4 Tips for 5G New Radio Signal Creation

A modern VSG with multiple, phase-coherent mmWave signal generation channels, wide modulation bandwidth, and high output power simplifies the test configuration for evaluating and optimizing 5G base stations and components.

Download the tips here:

literature.cdn.keysight.com/litweb/pdf/5992-3668EN.pdf

An aerial view of a city at night, with a network overlay of white lines and nodes connecting various points across the city. A large, glowing '5G' logo is centered in the middle of the image. The city lights are visible in the background, and the network lines are semi-transparent, allowing the city view to be seen through them.

5G

Testing 5G NR networks requires the capability to measure KPIs like end-to-end throughput, beam handling, mobility and handover rates.

Keysight's PROPSIM F64 Channel Emulator (CE) emulates real-life radio conditions, including all phenomena between the transmitter and the receiver. Using a reliable and repeatable method for testing RF condition tolerance in the lab ensures system-level performance.

Chapter 16 Spotlight on 5G Channel Emulation

A 5G NR massive MIMO performance test environment needs to register and measure the behavior of a phased array antenna using beamforming. Also, tracking regular network KPIs and RF-related performance is critical. Network KPIs include throughput at used and cell level, including peak and average values, handover success rate, service quality, and availability is critical. RF-related performance refers to signal quality and antenna performance. This chapter details test setups you can implement.

Testing Arrangements

Setting up a 5G massive MIMO base station performance test system to perform basic tests starts with setting up the test environment for 3D massive MIMO channel emulator testing. A recommended setup includes a 5G NR base station with phased array 8x2 connectors for two polarization layers — for a total of 32 connectors for the base station. There are four 5G-capable mobile phones with 2x2 MIMO antennas — resulting in a total of eight layers for mobile users.

You should then verify the system performance by executing the test. Create the test scenario to match the hardware configurations and see what indicators to pay attention to.

After testing with a full 3D massive MIMO test setup, you will see how to add capacity for higher base station configurations by compressing the elevation layer with a 1-to-4 combiner matrix. This process is referred to as a 2D massive MIMO setup since all the UEs remain in the same 2D plane after compression.

Building Blocks of the Massive MIMO Test Environment

The main building block of a massive MIMO performance testing setup is a multi-channel emulator. The 32-port base station could serve eight layers for the UE side using a single PROPSIM F64 channel emulator equipped with 64 channels (see Figure 16.1).

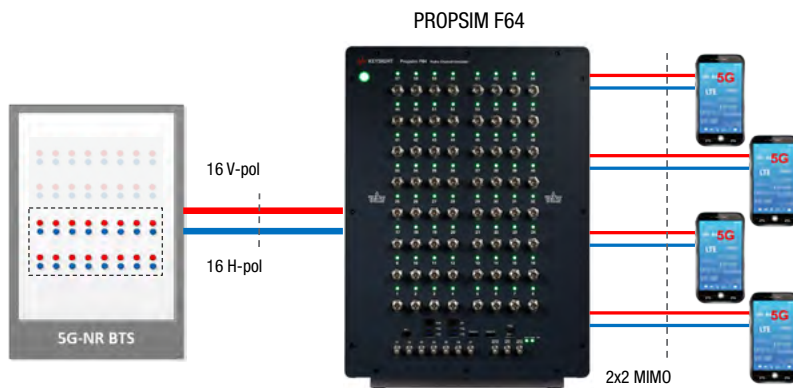

Figure 16.1. 5G NR base station with 16+16 antenna ports connected to 4 MIMO UEs through a single PROPSIM F64 5G Channel Emulator

With a PROPSIM F64-based setup, you can test both the base station and the terminal side of the connection. Use real equipment or simulated hardware to terminate the other end of the connection. Keysight provides full test solutions for both network and mobile phone testing needs.

You can use test and measurement equipment such as signal and spectrum analyzers within the same connection for monitoring system behavior and performance. To enhance the capacity of the channel emulator, combine multiple channels into a single port. The 2D massive MIMO performance testing setup section later in this chapter describes a test setup using combiners.

PROPSIM configuration	BTS TRX antenna examples	Phones	3GPP channel model compliant
F64 32 channels	16 Array (H/V pol.): 8x1, 4x2	4 single antennas or 2 with 2x2 MIMO	Yes Full 3D massive MIMO
F64 64 channels	32 Array (H/V pol.): 16x1, 8x2	8 single antennas or 4 with 2x2 MIMO	Yes Full 3D massive MIMO
2xF64 64 channels	64 Array (H/V pol.): 16x2, 8x4	16 single antennas or 8 with 2x2 MIMO	Yes Full 3D massive MIMO
F64 32 channels + 2x Combiners 1-4 x8	64 Array (H/V pol.): 16x2, 8x4	4 single antennas or 2 with 2x2 MIMO	No 2D massive MIMO

Table 16.1. Matching equipment to test needs

Table 16.1 provides typical examples of PROPSIM configurations for 5G base station testing. The different number of channels in PROPSIM determine the maximum antenna configuration — the bidirectional TRX ports connect to the base station antenna matrix RF ports. Phone devices or a multi-UE emulation product terminate the other side of the transmission. We use different software and tools to simulate the network traffic, such as the Keysight Ixia XAir3 UE emulation product.

The PROPSIM F64 configuration has 64 channels. The base station is using an 8x6 phased array antenna with cross-polarized planes, using 32 ports from the channel emulator. In the terminal end, we are using four mobiles with 2x2 MIMO. Figure 16.2 highlights the cabling in a typical test setup.



Figure 16.2. PROPSIM F64 offers the capacity to address the most complex configurations

Setting up a Full 3D Massive MIMO Performance Testing Environment

We use a full 3D massive MIMO test environment for network equipment testing. With this environment, we can evaluate the system-level and protocol stack performance of the 5G NR base station, including the phased array beamforming antenna system.

The PROPSIM F64 5G Channel Emulation solution runs 3GPP channel models. Tuning the phase and amplitude of the RF channels is essential in setting up the phased array. The built-in autocalibration feature helps in that regard.

Signal phase and amplitude calibration

The autocalibration function is available with a separate license, but if the primary function of the unit is 5G NR testing, this feature is a must-have. Route the reference signal to the ports to be calibrated to perform autocalibration. This method is a fast and accurate way to calibrate the signal phase and amplitude compared to using a vector network analyzer or other external tools to adjust the signal phase for each antenna connector (see Figure 16.3).

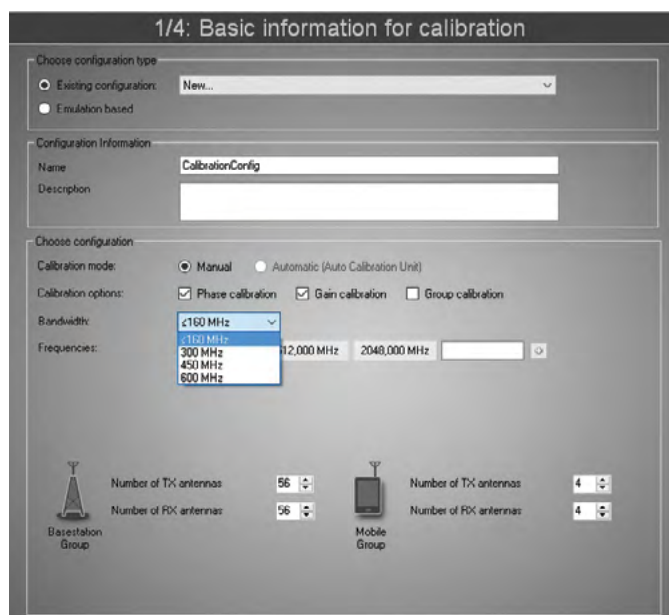

Figure 16.3. PROPSIM F64’s auto calibration feature saves time and effort

Channel models

The channel model determines the effects taken into account when transmitting the signal from the transmitter to the receiver. The channel model defines whether there are direct LOS or NLOS conditions, the types of reflected multipaths present, and signal attenuation and fading during transmission. PROPSIM software offers easy-to-use tools to create channel models, but 3GPP TR 38.901 also defines standard channel models. These channel models are available as ready-made files in the PROPSIM user interface.

Easy-to-use tools: PROPSIM's geometric channel modeling tool

The Geometric Channel Modeling (GCM) tool lets the user set up a virtual environment where all transmitters and receivers have a physical location and RF characteristics. Also, you can make the location, speed, direction, and orientation dynamic so that the radios move according to predefined paths with various speeds and orientations.

Use case scenario

The scenario tested includes a micro base station installed 35 meters above the ground on the wall of a building. Four MIMO UEs connect to the base station. The desired environment defines the channel models. In this case, we use the definitions for Urban Microcell Street Canyon from the 3GPP TR 38.901 (see Figure 16.4).

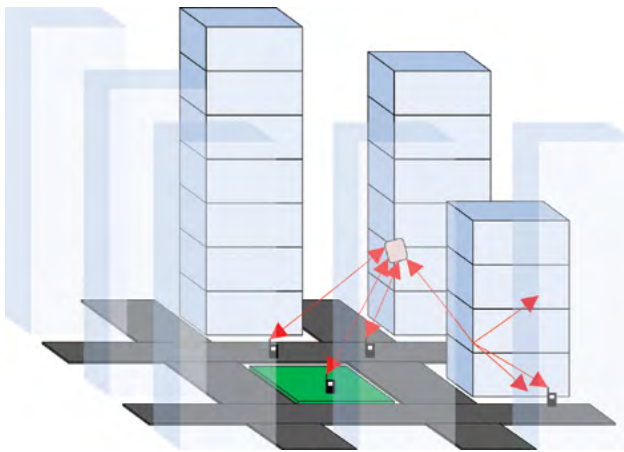

Figure 16.4. The Urban Microcell Street Canyon conditions to be simulated with the test setup

Scenario creation

Test scenarios should cover the verification of all necessary KPIs (e.g., throughput, desired RSRP level) and the performance and functionality of the system. PROPSIM's basic tools can create scenarios using standard-based stationary models, and PROPSIM's GCM tool allows the creation of dynamic geometry-based scenarios. GCM enables achieving essential realism by embedding antenna parameters with the optional Antenna Array Tool (AAT). This tool allows for the implementation of antenna radiation patterns. You can select the antenna from the existing antenna library or create one to reflect any proprietary antenna setup.

When modeling the base station antenna array with the AAT, you can set the antenna geometry and element characteristics realistically. First, define the kind of antenna, the number of elements, and the geometry between the elements.

In this example, we model the antenna as a cross-polarized array with 8x6 elements and an 80 mm separation between elements. Usually, the separation is around 0.4-0.5 wavelengths for effective beam formation. Element grouping enables one RF connector to host three elements from a single polarization plane. This results in $2 \times (8 \times 2) = 32$ antenna RF-connectors (see Figure 16.5). The element-specific ± 45 -degree radiation patterns are 3GPP predefined and available from the AAT.

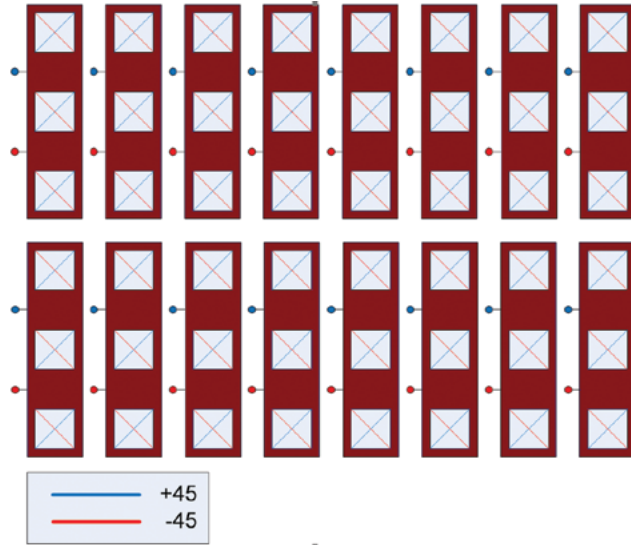

Figure 16.5. Antenna array with 8x2 connectors. Each connector holds a subarray of 3 elements

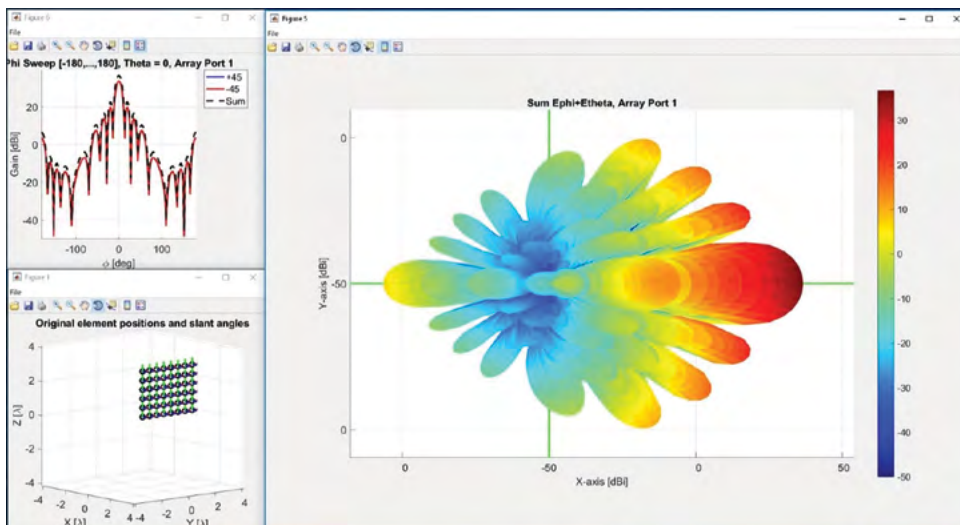

Figure 16.6. 8x6 array radiation pattern visualized with PROPSIM AAT

The antenna file format hosts the antenna radiation pattern in 3D format (see Figure 16.6). Also, the AAT maps the base station antenna ports to PROPSIM TRX ports. You need to account for the added antenna pattern in all transmitter to receiver calculations to achieve the highest gain when the main slope of the beam is oriented towards the UE. In this example, the UE antenna is modeled as a dipole.

Parameters to define with GCM + AAT	Example	Notes
Base station quantity and locations	1 to 3	Testing individual or group of base stations
Number of cells/base station	1 to 6	Single-cell or multi-cell
Number of UEs and movement	1 to 8	Up to 8 UEs per PROPSIM
Speed/waypoint	0 to 700 kmph	Static UEs or fast terrestrial UEs
Antenna definitions for both base station and UEs	Isotropic, omnidirectional, beamforming pattern	Use AAT
Link-level propagation parameters	LOS/NLOS, channel model, shadow profile	These define scenario-specific RF conditions
UE waypoint position-specific parameters	Speed, orientation, channel model	All UE-specific values can change per waypoint

Table 16.2. Parameters for base station test scenarios

After modeling the antenna, we specify the location of the base station and UE. The link characteristics between devices are defined in great detail. These are easy to set in the GCM, and the available ready-made standard channel models help in starting testing without previous knowledge on how to model RF conditions as channel models. Table 16.2 provides examples.

The software delivers additional information in the form of radiation patterns and other graphics, as demonstrated in Figures 16.7 and 16.8. The software lets you select just what you need (see Figure 16.9).

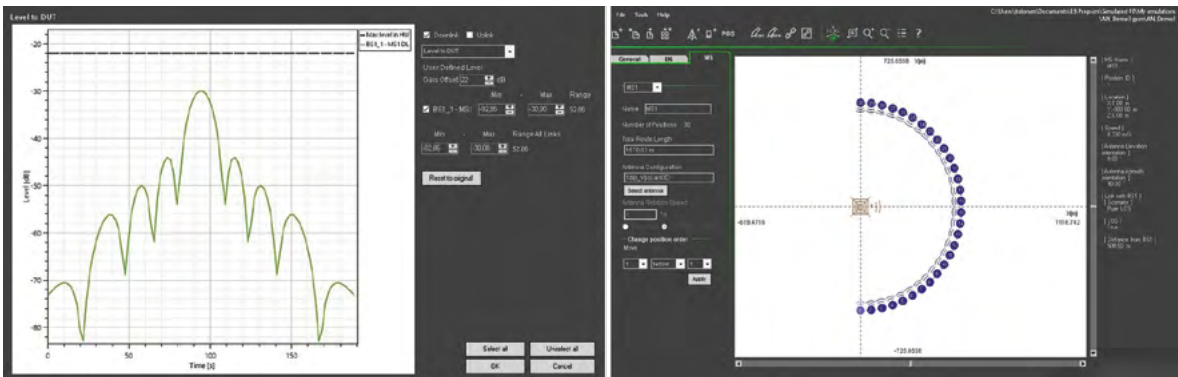

Figure 16.7. Beam shape becomes visible when UE moves in front of the 5G base station

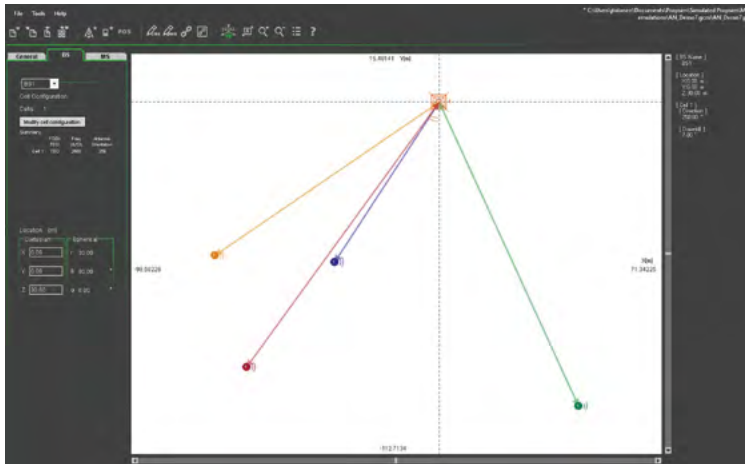

Figure 16.8. Setting base station and UE locations and orientations

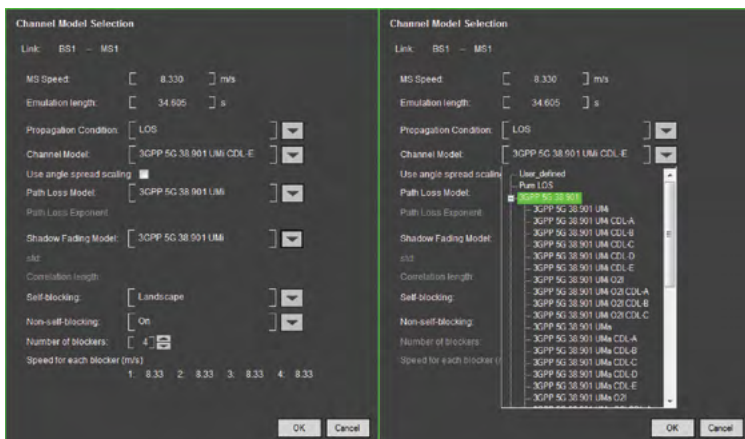

Figure 16.9. Selecting the link parameters and finding a suitable channel model from the channel model library

Finalizing the emulation scenario

After defining the scenario, load it into the simulator to double-check the values. The simulator scales the input and output power to current levels and copies the emulation in the channel emulator.

Setup cabling and configuration storing

After creating the scenario, PROPSIM Running View generates the model and renders it as an emulation topology. The ports of PROPSIM, the base station, and the UEs are defined to correspond with the allocated RF channels. These dedicated physical RF connections are typically permanent in the lab environment. Store the setup as a definition file called “lab setup” in PROPSIM. When attaching the RF cables, use a torque wrench to ensure a firm connection without breaking the connectors in the long run. Cabling is a critical part of this test approach, as illustrated in Figure 16.10.

The lab setup file offers a way to recall the desired physical setup in terms of channel allocation and also allows storing of the RF power levels, frequency, and many other parameters. Lab setup recalls defined parameters even though scenario parameters change. More information about how to use lab setup is available in the PROPSIM user manual.



Figure 16.10. Ensure connectors are firmly attached and always use good quality cables

Verification of signal chain

For KPI verification, the focus is on creating scenarios with a simple channel model, typically LOS and matching link levels. LOS requires the implementation of a Butler matrix that corresponds to the used antenna count to achieve MIMO gain. PROPSIM GUI facilitates this process by applying Butler Bypass, which calculates the desired Butler matrix as per the emulation in use and enables rapid fine-tuning of signal levels before proceeding to actual test cases.

You can then switch on the base station and UE and proceed with the synchronization process. After initialization, the FTP transfer can start. Meeting the actual power levels requires tuning PROPSIM's UL/DL input parameters. Monitor the base station and UE reporting to ensure compliance with the desired KPIs. By exporting the lab setup, you can fully reproduce the setup parameters in the future and speed up the testing time between environment parameter changes.

You can verify the beamforming implementation and visualize it by measuring beamforming gain levels from PROPSIM's output ports with external measurement tools. You can create a beam sector sweep scenario with the GCM tool.

Testing with Full 3D Massive MIMO Environment

When the desired test scenario is ready, you can load it on the channel emulator from Running View. At this point, the lab setup created earlier comes in handy. Taking into account the physical parameters before loading the emulation eliminates the need for further tuning, enabling a prompt test start. Now, trigger the KPI monitoring tools and start the emulation process. Figure 16.11 shows the runtime channel impulse response (CIR) graph view of the antenna subarray specific shadowing curve with blue lines and power delay-profile as green spikes.

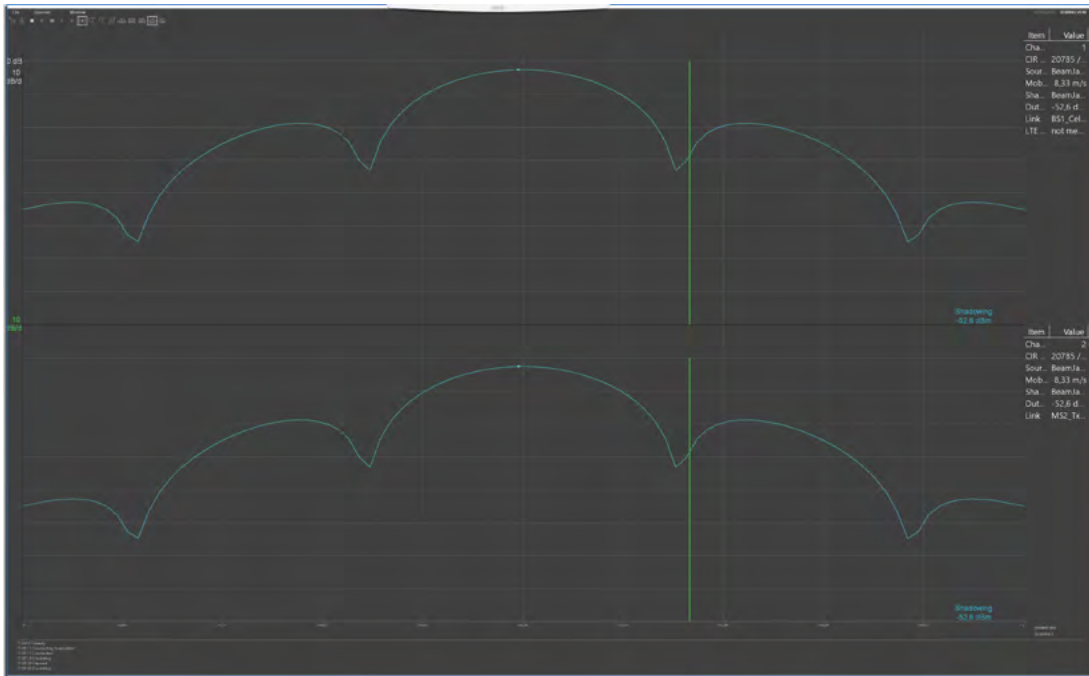

Figure 16.11. Runtime CIR graph view showing the antenna subarray specific shadowing curve

Analyzing test results

The PROPSIM family of products is not measurement equipment. After setting the environment to match the wanted RF conditions, you will need to use signal analysis tools to measure the relevant KPIs in the 5G system. KPIs include service availability, peak and average throughputs, handover success rates, and beam acquisition.

Introducing 2D Massive MIMO Environment

The main difference between the 2D and 3D massive MIMO performance testing environment is that the 2D environment base station signals are combined to use fewer TRX ports in the channel emulator. In practice, this means compressing the elevation angle to zero for all UEs. The UEs are in one single 2D plane from the point of view of the base station, as shown in Figure 16.12.

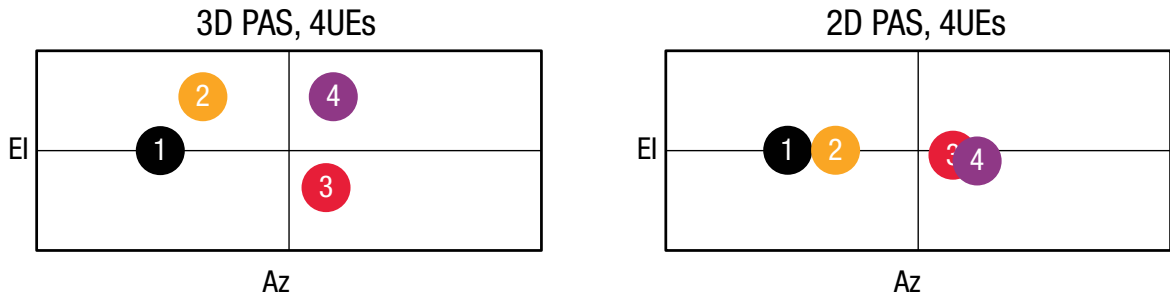

Figure 16.12. After combining, the users are in one plane in power angular spectrum (PAS)

The 2D massive MIMO environment setup reduces the number of connectors needed in PROPSIM. This reduction results in a smaller configuration or an increase in the number of users without adding channel capacity (see Figure 16.13). The channels are combined using wideband power combiners. Keysight offers 1-to-4 combiners and a combiner matrix with multiple combiners in a single casing. Up to eight units of 4-to-1 combiners fit in one combiner matrix.

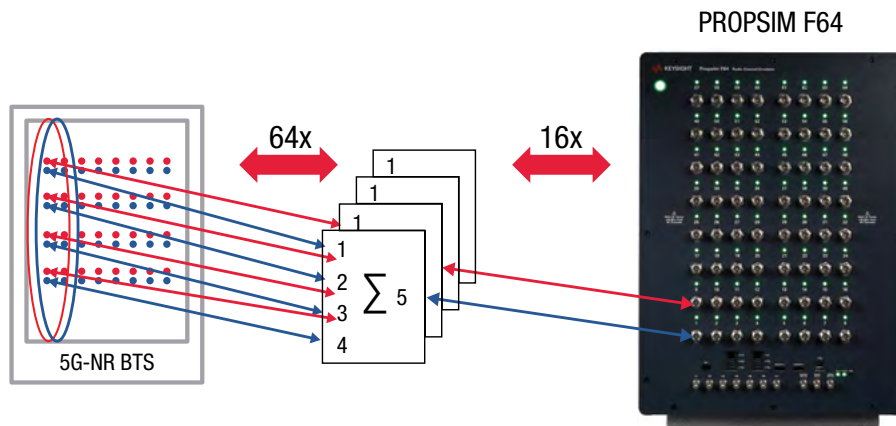

Figure 16.13. Combining the vertical layer of the phased array to save ports in the channel emulator

Analyzing test results

From a base station perspective, the results are similar to those of the 3D setup, but the angular information looks completely different with the compressed elevation axle. Still, you can use all the dynamic elements in testing, just like with the full 3D environment.

Signal-Based Calibration

Using PROPSIM's integrated input measurement-based calibration is an important consideration. To calibrate the phase of a defined massive MIMO antenna, PROPSIM uses an incoming external signal. This procedure is a user-friendly, time-saving, and accurate calibration approach because it does not require removing the test setup/measurement cables from the application environment. Phase calibration compensates the phase difference between the input signal from a real base station with the massive MIMO antenna system. The reference signal can have a random phase offset depending on the base station equipment unit, the band used, and cell state.

This calibration is operated over the automatic test equipment (ATE) remote interface and is a relative pair-based measurement, measuring through the desired MIMO matrix in pairs compared to a defined reference channel. Figure 16.14 shows one configuration.

This calibration method does not depend on the size of the MIMO matrix but on the capability of the base station to feed the cell-specific reference signal (CRS) to a sufficient extent and in the correct format. CRS signal transmission is based on two antenna port resource elements mapping as defined in section 6.10.1.2 of TS 36.211. With a larger MIMO matrix, the CRS feed needs to be set to transmit CRS 0 and CRS 1 in a manner that enables pair measurements covering all ports (e.g., 16 element antenna-ports 1 – 8 CRS 0 and 9 - 16 CRS 1). MIMO antenna count is defined to quantify the step count of measurements.

During the phase calibration process, PROPSIM detects the presence of the CRS coming from the LTE signal as per the defined settings. A valid LTE signal triggers the analysis of the phase difference between the input signals. Input phases can be measured and adjusted to compensate for the phase differences.

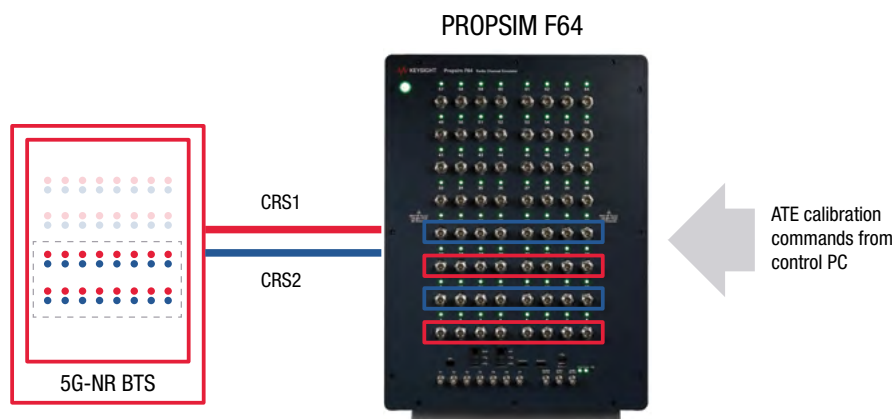

Figure 16.14. Connection example for calibrating the channel emulator with ATE commands

Test procedures for 5G are detailed and complex, but the right tools can help simplify the setup, simulation, and measurement of KPIs crucial to your design.

Chapter 17

Rapid Characterization of 5G Components

5G represents significant revenue potential for the entire mobile ecosystem, from component manufacturers through MNOs. But it also represents an exponential increase in technical complexity. Massive MIMO antennas, for example, require multiple transmission and reflection measurements for each antenna element.

Component manufacturers need to deploy effective strategies for characterization and test regardless of the component type (amplifiers, mixers, converters, etc.). To win the 5G race, component manufacturers need greater confidence across the workflow.

Measurement integrity is essential to gain deeper insights into designs in R&D. To stay competitive, component manufacturers also need to accelerate time-to-market and reduce test costs. The high throughput of true multiport test setups gives component manufacturers the performance they need to keep up with aggressive timelines.



In the component workflow, thorough testing enables better designs and more competitive components. Component manufacturers should deploy instrumentation with common hardware and software elements to accelerate the component workflow.

The proliferation of RF has increased customers' expectations for greater capabilities and lower prices. Components are critical to addressing these opposing forces through greater integration and economies of scale. Component manufacturers need to deploy strategies that accelerate innovation and time to market.

Maximize Multiport Device Testing with Optimized Instrumentation

5G generates significant multiport challenges. Massive MIMO, for example, requires massive multiport testing to characterize antenna performance. 5G NR FR1 requires up to 66 ports. An 8x8 MIMO configuration requires 64 ports for antenna measurements. Manufacturers also typically need two calibration ports.

Components feature an increasing number of ports. The need for multiport characterization in component test is growing. Instrumentation optimized for multiport measurements ensures comprehensive DUT support and helps achieve high measurement performance and accuracy. This increases measurement throughput, minimizing the cost of test.

Switch-based vector network analysis solutions have traditionally addressed multiport testing needs. However, many multiport devices require measurements from each port to every other port. Simple switch test setups cannot address this requirement. Switch-based solutions do not support all the paths for multiport devices.

Component manufacturers can use full crossbar setups in place of simple switch setups. Such setups offer complete measurements between each port. However, they typically require full N-by-N calibration for every case. Also, setups featuring solid-state switches are sensitive to temperature. They require frequent calibration to ensure accurate measurements. More stringent calibration requirements impact throughput.

Modern multiport devices also increase the need for faster and more accurate measurements. As the number of ports increases, the number of sweeps needed to route test signals to each DUT port skyrockets. Switch attenuation impacts the dynamic range, reducing measurement performance.

True multiport VNAs reduce loss because they do not need switches. A VNA optimized for multiport testing also supports all the paths for multiport devices. A wide dynamic range enables them to perform sweeps quickly. An increase of 20 dB in dynamic range can lead to a 100x improvement in measurement speed. With simultaneous data capture, multiple ports are measured concurrently, accelerating the testing process.

Leverage Different Platforms to Reduce Test Footprint

Instrumentation comes in different form factors: benchtop, modular, and universal serial bus (USB). Each form factor has its own benefits and finds adoption in different phases of the component workflow (R&D, design validation, and manufacturing). Component manufacturers need to devise test strategies that capitalize on each form factor's advantage across that workflow.

Flexibility is essential in component manufacturing applications. Modular instrumentation allows multiple instruments (signal generator, signal analyzer, network analyzer) to be combined in one chassis, providing robust test systems while minimizing footprint. Configuration flexibility lets component manufacturers align their test systems with their application requirements. It also enables them to scale configurations as application needs change.

With Keysight's M980xA Series PXIe VNA, for example, component manufacturers can address different 5G massive MIMO antenna requirements using:

- 17 two-port modules to create a 34-port VNA solution in a single chassis
- Eight six-port modules and one two-port module to achieve 50 ports in a single chassis
- 11 six-port modules in two chassis to reach 66 ports

Modular instrumentation also saves space. A smaller test footprint reduces test costs because contract manufacturers typically charge by the square foot. With PXI, component manufacturers combine modules to develop powerful test systems that use less floor space than systems consisting of box instruments. Figure 17.1 shows the increasing number of ports and the complexity of various components.

Complexity/functionality

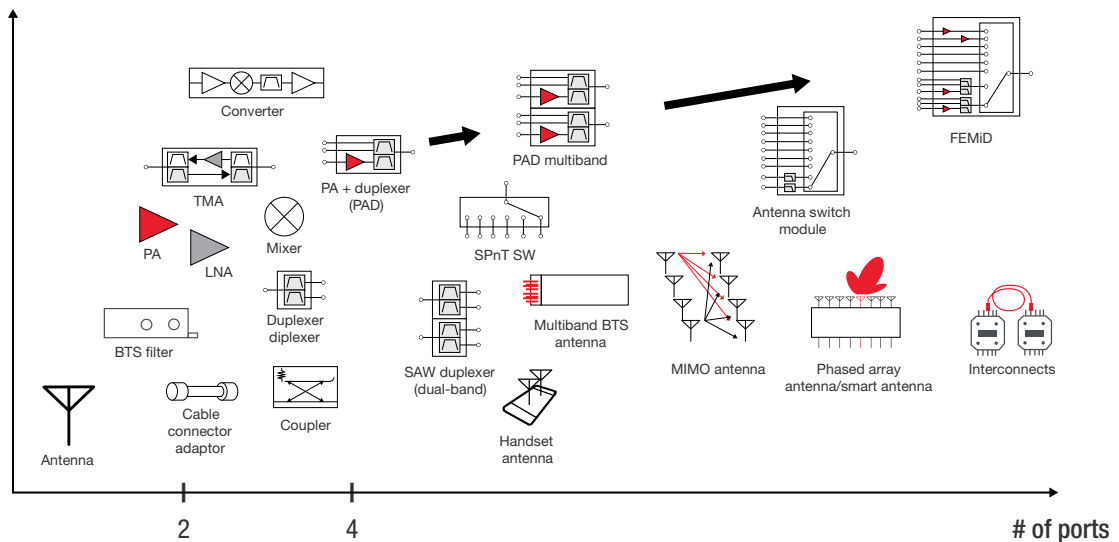

Figure 17.1. DUT map by complexity and port

**Organization:**

Component manufacturer, A&D

Challenges:

- To be first to market with a 5G antenna that provides 1 GHz bandwidth at mmWave frequencies
- Characterizing phased-array antennas using complex 5G signals

Solution:

Keysight 5G waveform generation and analysis testbed with benchtop signal analysis

Results:

- Proving design performance with accurate, repeatable OTA measurements (achieved 1% EVM performance)
- Rapidly revising antenna designs to meet the specific needs of individual customers

Chapter 18 Revising Antenna Designs for New Requirements

Ultimately, the 5G future will include new experiences enabled by ultra-high data rates and reliability, and ultra-low latency and energy requirements. These goals depend on advanced phased-array antennas capable of implementing innovative technologies such as massive MIMO and beamforming. The antenna arrays will also handle digitally modulated signals operating at mmWave frequencies. Collectively, these changes have major implications for the process of designing and testing antenna arrays.

A U.S. manufacturer of components for aerospace and defense aimed to be first to market with a 5G antenna providing 1 GHz of bandwidth in specific mmWave bands of the 5G frequency allocations. Achieving this goal required a major change in the manufacturer's antenna testing process, including a shift to OTA characterization using signal generation and signal analysis at mmWave frequencies. Keysight provided the tools the design engineers needed to characterize the digitally modulated signals that mmWave phased arrays generate over the air.

The Challenge: Characterizing Array Performance

Device makers need new antennas designs that provide reliable and high-speed connections. To address the specific needs of customers developing 5G devices, the company's engineering team needed to enable the fine-tuning of antenna performance through rapid design changes. The team needed a way to fully characterize the transmit and receive paths to understand and prove the performance of each design variation. OTA testing techniques were necessary because the antennas operate at mmWave frequencies.

Before the 5G program, the development team validated antennas in a test chamber using a VNA. However, the signal generator in the VNA was not capable of producing 5G NR waveforms carrying digital modulation. Applying realistic 5G NR signals is essential to fully characterizing antenna and array performance.

The Solution: Adapting and Applying a 5G Testbed

The solution was to find, adapt, and apply an antenna testbed such as the Keysight 5G R&D Test Bed (Figure 18.1). This solution can meet a wide range of test requirements, including 5G NR (3GPP), pre-5G (5G Technical Form), and custom OFDMA waveforms.



Figure 18.1. This configuration of the 5G R&D Test Bed supports 3GPP NR signal creation up to 44 GHz (lower left) and includes benchtop spectrum analysis up to 50 GHz (right), both with integrated 1 GHz bandwidth

Simulation and verification through real-time beamforming and beam tracking were essential capabilities for this use case to simulate real-world environments. RF channel in-phase/quadrature (I/Q) constellation, EVM, antenna pattern, and beam width were crucial measurements. EVM is an industry-standard for signal quality used to measure the performance of an RF signal. More stringent specifications for RF performance increase the importance of EVM measurements, particularly in R&D and design validation.

The Keysight 5G R&D Test Bed solution includes Keysight hardware and software elements for signal generation and signal analysis. The system uses a Keysight M9383A PXIe microwave signal generator and Keysight PathWave Signal Generation (Signal Studio) software to produce 5G NR signals. The M9383A provides 1 GHz bandwidth across a frequency range of 1 MHz to 44 GHz. Developers download 5G NR signals created in PathWave Signal Generation (Signal Studio) to the M9383A. During testing, the M9383A connects directly to the antenna array under test, and the resulting signal is beamed at the signal analyzer.

For signal analysis, the solution includes a Keysight N9040B UXA signal analyzer and Keysight PathWave 89600 VSA software. An antenna connected to the UXA provides the input signal. The PathWave 89600 VSA software enables demodulation and detailed analysis of 5G NR signals (Figure 18.2), including EVM, which is the key figure of merit for measurement quality. Different views make debugging easier, accelerating development time.

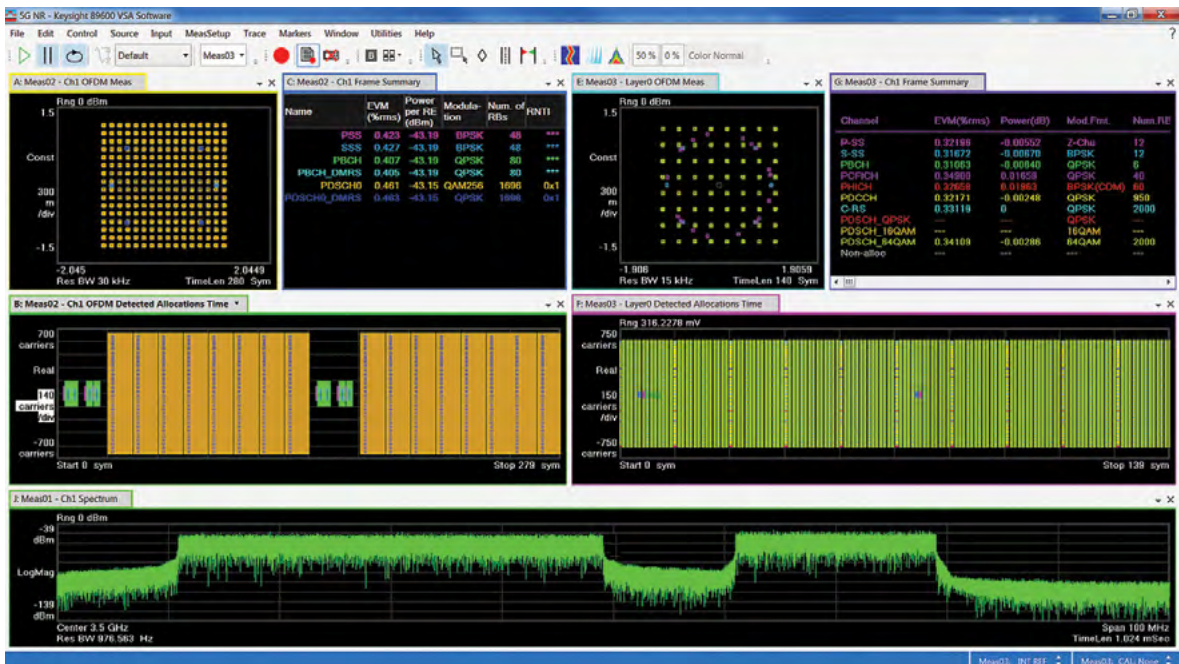

Figure 18.2. In this side-by-side multi-measurement display, the Keysight PathWave 89600 VSA software shows demodulation of 5G NR and LTE carriers

The Results: Rapidly Characterizing Revised Designs

Using the Keysight 5G R&D Test Bed, the component manufacturer's engineers were able to perform accurate and repeatable OTA testing using 5G NR signals. One exceptional result: the testbed can measure one percent EVM in the OTA configuration. The company was able to show its customers the true performance of each 5G phased-array design.

Additionally, the testbed enables the creation of real-time 5G signals and instantaneous measurements of the transmit/receive channel. With these capabilities, the component manufacturer achieves complete test coverage, meet 5G device makers' need for more performance, and can make rapid design changes in response to evolving requirements.

Going Forward

The future success of 5G depends on speed, whether it is in the creation of devices, the deployment of networks, or the performance of those devices and networks. In the run-up to 5G, the faster component manufacturers respond to multiple unique requirements, the faster their customers launch devices. Keysight's solutions equipped this component manufacturer to achieve this goal. For example, the company introduced a development tool to help its customers accelerate their projects.

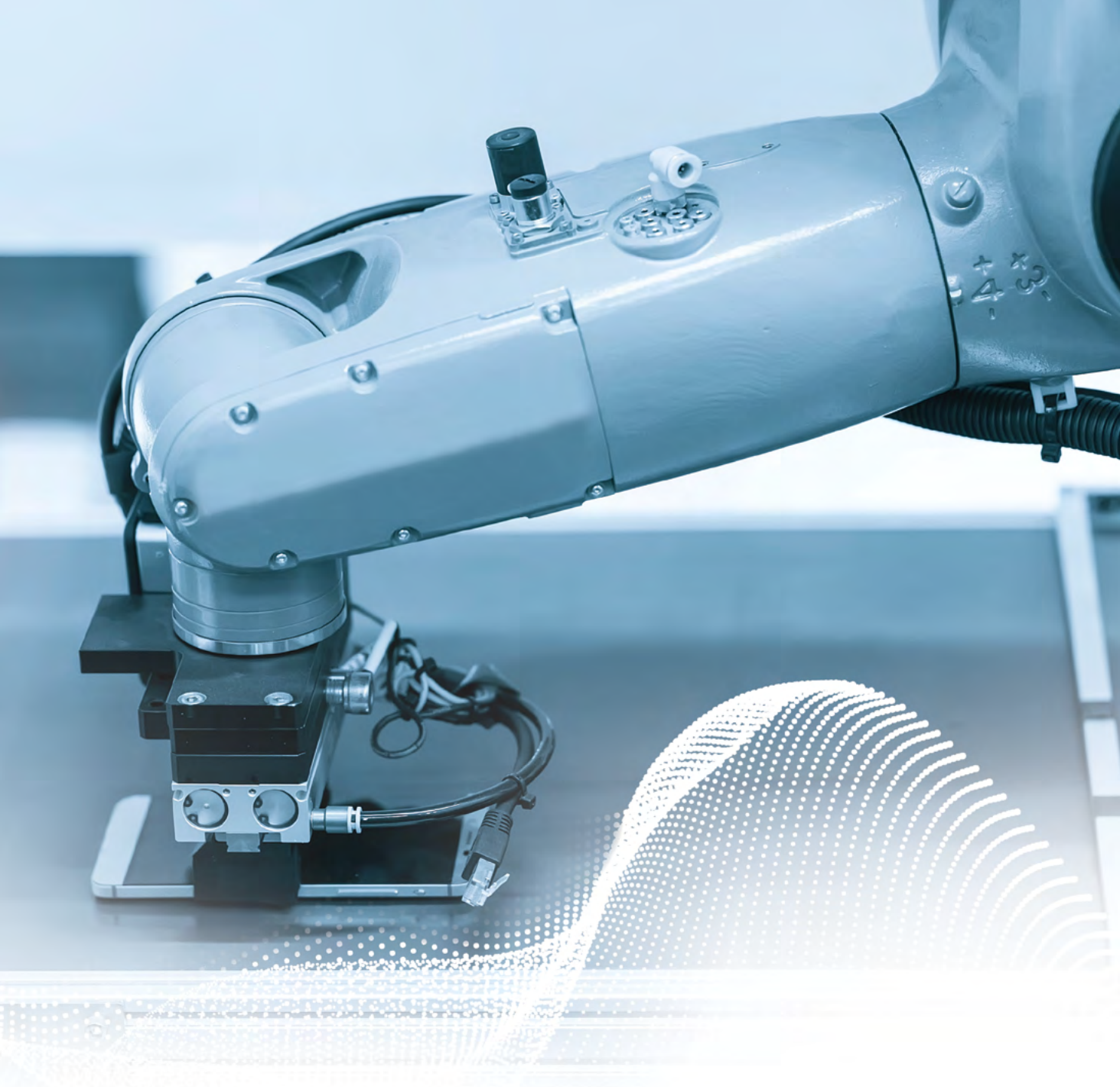

Chapter 19 Mastering 5G NR Manufacturing

5G is moving fast. Participants across the mobile ecosystem are eager to capture the new revenue streams from 5G business models. NEMs and component manufacturers are moving full-speed ahead towards commercialization. The industry needs to take 5G through the manufacturing workflow from NPI to HVM as fast as possible.

NEMs and component manufacturers need to overcome new manufacturing test challenges not faced in 4G. With continuous standard evolution, flexibility in manufacturing test operations is critical. Base station manufacturing test engineers must address more frequency bands, mmWave frequencies, and wider bandwidths. Component manufacturers need to devise new strategies to reduce their test footprint, increase their flexibility, and boost throughput — all to reduce the cost of test.

Taking base stations and components through the testing workflow for 5G is not easy. Component and base station manufacturers need to overcome significant challenges while also coping with tremendous time-to-market pressure. They must master the complexities of 5G to innovate, transform, and win in 5G quickly.

NEMs and component manufacturers must surmount the challenges coming from 5G NR, MIMO, and mmWave frequencies to achieve success in 5G. Innovative solutions are required to contain test equipment footprint and lower the cost of test.

1. Overcome Path Loss with System Calibration and Remote Heads

Before 5G, commercial communications mostly resided at low frequencies. Most testing was performed via conducted methods. Attracted by the spectrum availability in mmWave frequency bands, the industry is shifting to higher frequencies. The move to mmWave frequencies requires base station designers to use different architectures like phased-array antennas. These architectures cannot support conducted connections, forcing test verification to happen over the air. Higher frequencies combined with OTA testing result in much more path loss than previous test methods.

mmWave radiated testing is entirely new to cellular manufacturing and presents significant challenges for NEMs. Switch matrices and long cables incur high losses. Air absorption, high insertion loss, and fragile and expensive connectors reduce dynamic range and impact measurement quality.

It is imperative to accurately compensate for path loss with system calibration, and by reducing the distance between the DUT and the OTA chamber. Remote heads allow for long cables at low frequency and power to drastically reduce insertion loss while improving phase linearity and connector robustness. The added gain in the remote heads also improves dynamic range. Figure 19.1 shows how a remote mmWave transceiver head reduces insertion loss in an OTA test setup.

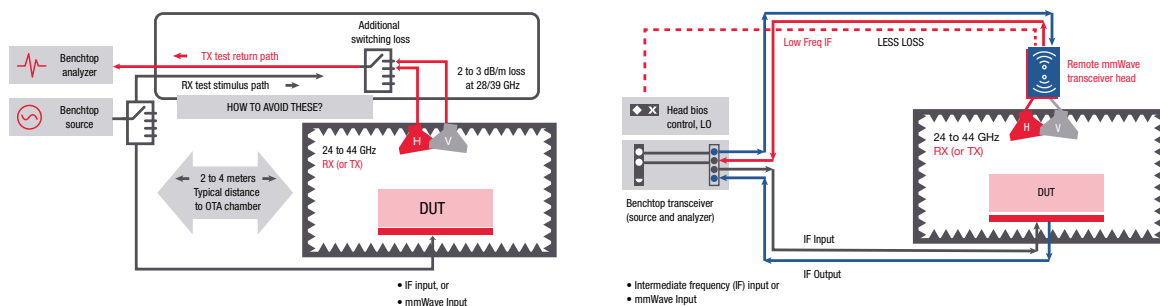

Figure 19.1. OTA test setups with and without a remote head

2. Reduce the Cost of Test with Multiport and Multisite Testing

Higher performance requirements and the need for more test equipment and OTA chambers place new demands on the production floor. These factors impact the cost of test because contract manufacturers typically charge by the square foot. Without multiport testing and high-density test systems, the test equipment footprint will increase significantly in 5G. A larger test equipment footprint means higher real estate costs or a reduction in production capacity.

5G increasingly uses multiport designs and multi-element MIMO arrays on both UEs and base station installations. Multichannel scalable test equipment is critical to base station testing. It helps NEMs contain the test equipment footprint and the cost of test. Equipment scalability is essential to transition from testing 8-port 4G devices to 5G with 16, 32, 64, and 128 channels.

Components also feature an increasing number of ports. Instrumentation optimized for multiport measurements ensures comprehensive DUT support and helps achieve high measurement performance and accuracy. It also helps increase measurement throughput, minimizing the cost of test.

Manufacturers can implement multisite configurations on top of multiport testing to optimize throughput. Multisite testing involves multiple instruments running on the same chassis to test several devices simultaneously. These measurement techniques can help maximize throughput for multiport devices with high isolation, such as front-end modules that do not require isolation tests between high and low bands. Multisite testing enables simultaneous sweeps, reducing test times and increasing throughput.

Since parallel testing increases throughput, it also reduces the cost of test. Parallel testing is of great interest to manufacturers of passive components, surface acoustic wave (SAW) devices for mobile handsets, and general-purpose components such as antennas, filters, and cables in the manufacturing stage of the component workflow. In the past, manufacturers would stack traditional instruments in racks to perform multisite testing. Modular instrumentation enables faster throughput and greater flexibility in a much smaller footprint. It measures multiple paths of the DUT simultaneously and enables component manufacturers to test similar or different devices at the same time.

While modular instrumentation provides significant benefits, component manufacturers must pay attention to potential central processing unit (CPU) issues. The controller performs more computational work as the number of VNAs in the test station increases. This eventually impacts processor performance. Also, the VNA's IF bandwidth (IFBW) setting affects measurement speed and throughput when running multiple VNAs in a single PXI chassis. Component manufacturers can scale far beyond one core per VNA for low IFBWs, such as 1 kHz.

Multisite capability also enables multiuser test solutions. This capability is of interest to component manufacturers for applications such as filter tuning because it allows for low-cost manufacturing. Component manufacturers can route the outputs of an embedded controller to monitors or use an external controller. They need to configure the computer operating system for multiple displays and ensure that it recognizes the different test stations. Also, they must minimize control time using graphical macros for operators to avoid errors.

3. Reduce Test Times and Costs with FPGA Processing and the Cloud

In the race to 5G, NEMs and component manufacturers need to test their products fast and thoroughly. They must do so while reducing the cost of test for 5G to be commercially successful and to drive top-line growth and profits. New techniques like FPGA processing and the cloud can help reduce test times and costs.

Accelerated measurements help test engineers start closer to the finish line. PXIe's high-speed data handling capability and deep measurement expertise built into hardware-based FPGA measurements yield significant reductions in test times. This capability translates into increased test speed across power and frequency ranges for multiple channels and radio formats in base station testing.

Cloud data processing can help test throughput reach extremely high levels. In a typical approach, the test equipment acquires the test data and calculates the measurements sequentially. In a cloud-based approach, the computing workload is in the cloud. Critical calculations now run in parallel on faster cloud-based servers. The test architecture is more efficient, increasing measurement throughput. It also increases test asset utilization and flexibility, enabling manufacturers to repurpose test stations.



Company:

5G transceiver manufacturer

Key issues:

- Fast testing of large transceiver arrays
- Underutilized test hardware

Solution:

- Keysight consulting services
- PathWave Test software
- PathWave Manufacturing Analytics

Results:

- 20X test speed improvement
- 10X improved asset utilization
- Flexible test station repurposing from 3G to 5G

Chapter 20 Reducing Test Time

A leading manufacturer of multi-antenna high-frequency 5G transceivers needed a technology partner with a comprehensive test platform that included hardware, software, and services. Working with Keysight, they achieved a 20X improvement in speed, 10X improvement in asset utilization, and easily repurposed their test stations.

Challenges: Traditional Test Approach Lacked Readiness

A worldwide transceiver manufacturer made a substantial investment in the design and manufacture of equipment for 4G and new 5G networks. Their 5G product designs include arrays of massive MIMO radio transceivers that need to operate at higher mmWave frequencies than 4G equipment. The test team needed a manufacturing test platform that could handle an increasing number of transceivers and antennas at mmWave frequencies. The test platform also needed to perform OTA measurements quickly.

The new test architecture had to be flexible. Since 5G is an emerging standard, many of the required tests are not fully defined. The new frequency bands with numerous channels are at higher frequencies than 4G networks. The test equipment must manage mmWave measurements potentially up to 71 GHz on up to 128 transceivers and must include OTA testing.

Figure 20.1 is the manufacturer's test approach using a multi-channel RF measurement system with a PC controller to compute the desired test parameters sequentially. For example, EVM, spectrum emission mask (SEM), and ACP align with one specific signal format. Test times with this approach increase linearly with more channels and quickly become cost-prohibitive. Moreover, the test hardware sits idle while the calculations are run, causing the under-utilization of test assets.

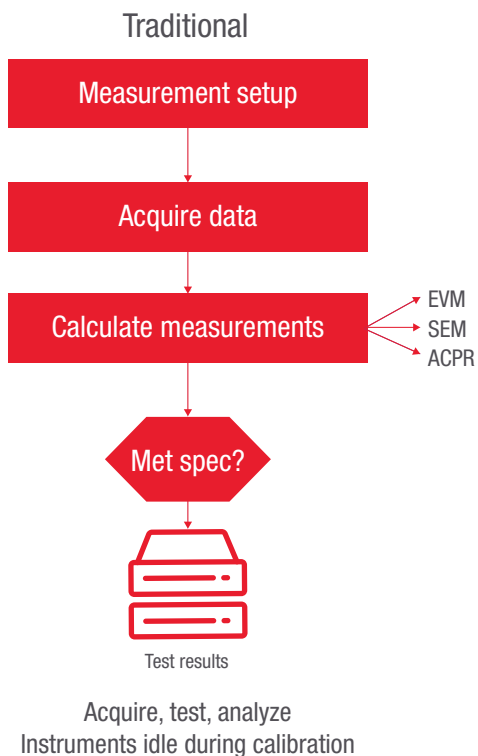
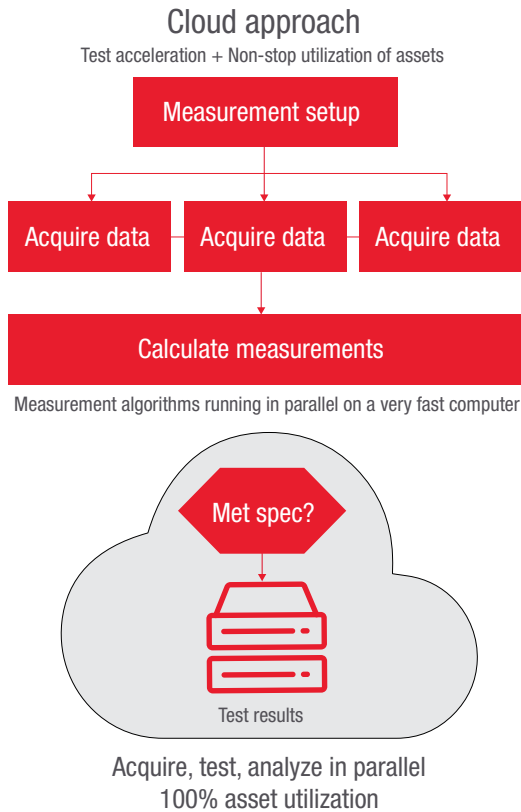

Figure 20.1. The traditional approach to testing 5G transceivers

Solution: A Breakthrough with Distributed Architecture

The company partnered with Keysight Technologies to create a new test strategy using a cloud-based concept shown in Figure 20.2. In this approach, the test hardware continuously acquires measurement data while private cloud servers handle the computing workload. The critical calculations run in parallel on the faster servers, providing significant speed improvements. The test equipment is now fully utilized with minimal idle time, resulting in higher asset utilization and lower capital expenditure.



“This customer needed a breakthrough approach to testing multi-antenna, high frequency products. We proposed a distributed processing approach using computing resources on the customer’s private cloud servers.”

Applications Engineer, Keysight 5G Specialist

Figure 20.2. PathWave software enables parallel measurements and faster processing in the cloud, dramatically improving test speeds

Figure 20.3 shows the overall test solution architecture. Modular PXI hardware provides the necessary test signals and acquires the time and frequency data needed for the transceiver electronics, including power supplies, filters, digital, and RF sections.

PathWave Test manages the test sequences across the various test stations. High-powered network computers collect the data from the remote test stations to quickly compute the required measurement parameters — EVM, SEM, and ACPR — using PathWave. Those results are available in a central database for easy access and analysis via PathWave Manufacturing Analytics software.

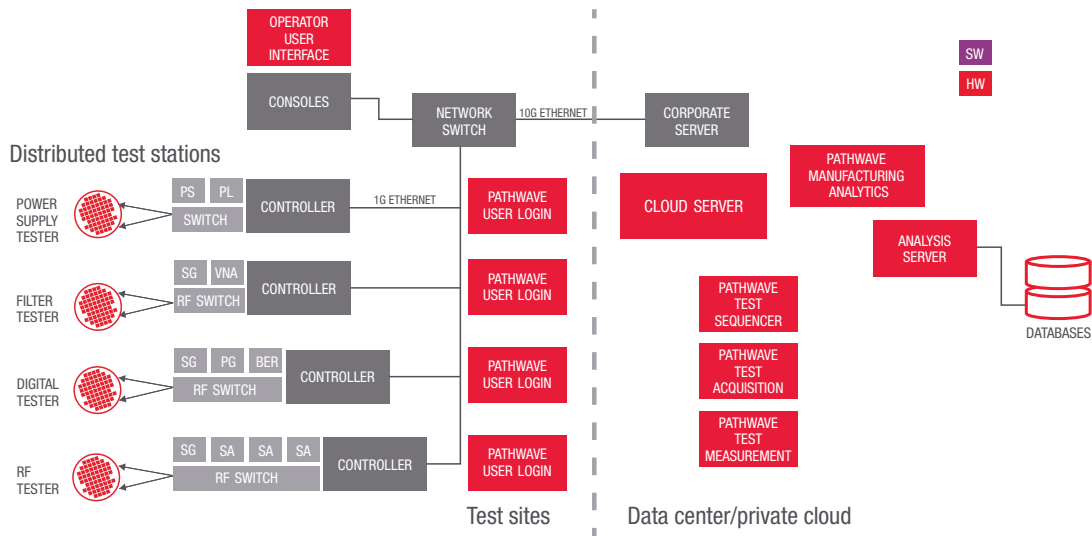

Figure 20.3. PathWave software provides significant test speed and asset utilization benefits

The new test architecture is more efficient, with measurement algorithms shared across test stations and easily updated to support new signal formats and hardware. Authorized users manage and update the test station software remotely. By reconfiguring the software, test stations are modified to test any device across a variety of signal formats from 3G to 5G. PathWave test software provides fast measurements for every format via the cloud server. The solution increases manufacturing flexibility because each test station is used to test a wider variety of products.

Results: Preparing for the 5G Future

With Keysight’s solution, the manufacturer successfully accelerated the process of commercializing its 5G transceivers. Keysight’s high-precision measurement tools helped the manufacturer shorten its workflow and reduce complexity.

PathWave’s innovative test approach enabled the manufacturer to quickly improve its speed. The company reported a 20X increase in measurement throughput by moving data processing to their cloud servers. The resulting increase in test speed and reduced idle time resulted in a 10X asset utilization improvement. The flexibility of the test architecture allowed the manufacturer to repurpose test stations across a variety of 3G to 5G transceivers.

“Keysight showed us a comprehensive approach to testing 5G that included measurement hardware, PathWave software, and Keysight Engineering Services to give us confidence in their strategy. They really understood our problem and helped us develop a solution that enables us to transform and win in our markets.”

Design & Test Director

Chapter 21

Solutions that Streamline the 5G Workflow

NEMs building 5G base stations need to integrate complex multichannel antenna arrays from sub-6 GHz to mmWave frequencies. They also need to deliver lower latency and support a comprehensive range of machine-to-machine user behaviors. In addition, more demanding users and the competitive nature of the commercial wireless communications industry make it critical for NEMs to validate network equipment performance.

In manufacturing, increasing device complexity, finding breakthroughs to lower the cost of test, and reducing time to market are the top challenges. NEMs must find ways to test infrastructure equipment cost-effectively and remain flexible to address spikes in volume, channel requirements, and more frequency bands.



Keysight partnered early with chipset makers, device manufacturers, and network operators to understand 5G challenges for designers. The goal: to deliver innovative 5G design automation, waveform and signal generation analysis, and OTA test solutions. Keysight solutions accurately emulate and measure 5G devices, operator networks, and extensive subscriber behavior scenarios. Keysight's expertise and solutions for RF design and IP networking accelerate testing of base stations and their sub-assemblies and reduce the cost of test.

Design Automation Solutions

PathWave System Design (SystemVue)

Keysight's PathWave System Design (SystemVue) is an electronic design automation (EDA) environment for electronic system-level designs. The software enables engineers to innovate the physical layer of wireless communication systems. The solution features baseband exploration and verification libraries to create and quickly verify algorithms and high-performance system architectures. It also includes application personalities and design kits for more in-depth analysis and implementation tasks. Beam performance in a system is a key application addressed with PathWave System Design.

PathWave Advanced Design System

Keysight's PathWave Advanced Design System (ADS) is the industry-leading EDA software for RF, microwave, and high-speed digital applications. Engineers can verify their designs for both existing and emerging wireless standards with the Wireless Libraries. The W2383EP 5G Modem Library for PathWave ADS enables the verification of designs for the new 5G standards.

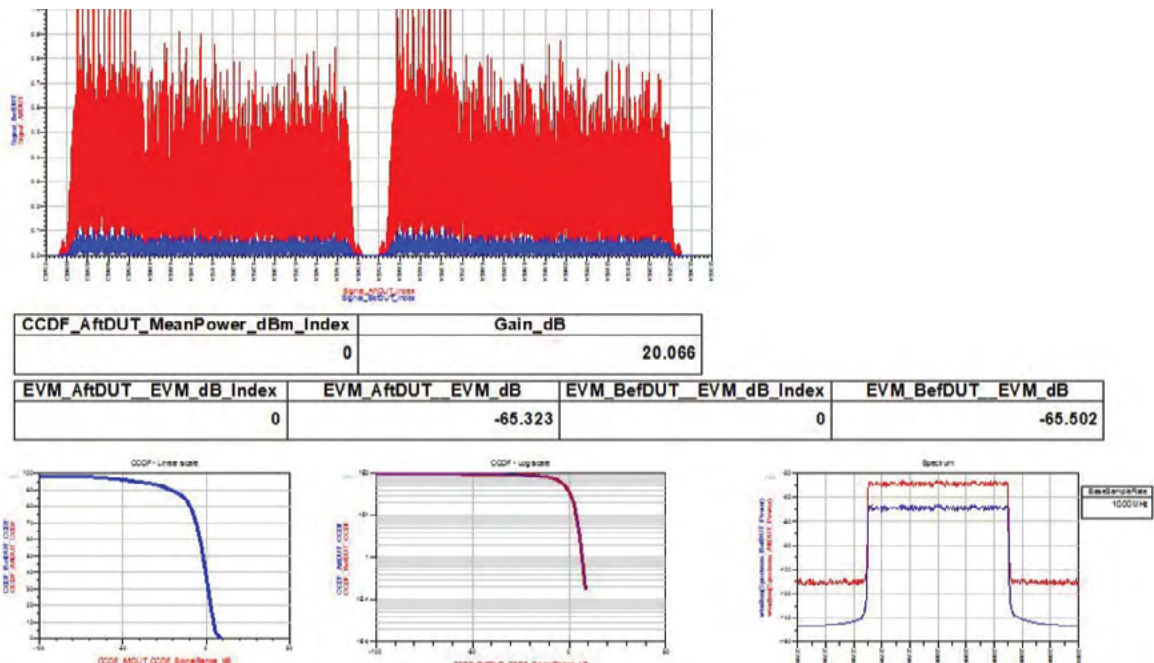

W2383EP 5G modem library for PathWave ADS

5G Waveform Generation and Analysis Solutions

Keysight's 5G waveform generation and analysis solution generates and analyzes 3GPP standards-compliant and custom 5G waveforms at FR1 and FR2 mmWave frequencies. Instruments are fully calibrated at the factory to enable metrology-grade measurements at 5G frequencies, amplitudes, and modulation bandwidths. Easily accomplish de-embedding by importing the S-parameters of the test fixtures to move the calibration plane to the DUT interface.

Wideband RF/mmWave signal creation



X-Series signal generator with PathWave Signal Generation (Signal Studio) software and X-series analyzer

Wideband RF/mmWave signal analysis



5G new radio modulation analysis PathWave 89600 VSA software (option BHN)

Network Analysis Solutions

Keysight's network analysis solutions include the PNA and the Streamline series of network analyzers. The PNA series enables engineers to perform passive and active device characterization. It offers unrivaled performance for traditional S-parameter measurements. As the most integrated and flexible single-connection multi-measurement microwave test engine, it can replace racks of equipment. The simplified setup saves engineers time when tackling complex measurements. The Streamline series of USB network analyzers bring the performance of benchtop instruments in a compact form factor so they can be easily shared between test locations. In addition to featuring Keysight's trusted network analyzer user interface and advanced measurement applications, engineers can cascade these instruments for multiport measurements.



PNA-X series



Streamline USB series

5G Channel Sounding Solution

Keysight's 5G Channel Sounding Reference Solution consists of multiple hardware and software elements to provide multichannel, wideband signal generation and analysis for the characterization of 5G radio channels. This solution helps research engineers to advance 5G channel modeling at mmWave frequencies.

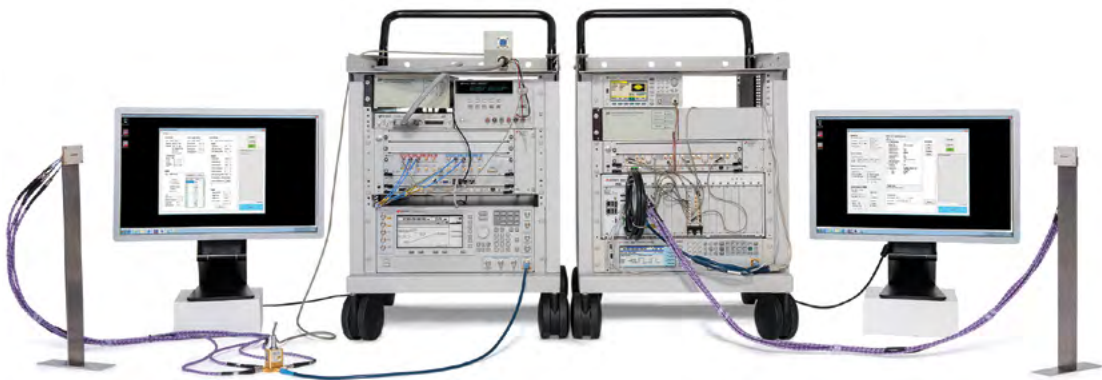

Keysight's 5G Channel Sounding Reference Solution

5G Channel and UE Emulation Solutions

5G channel emulation

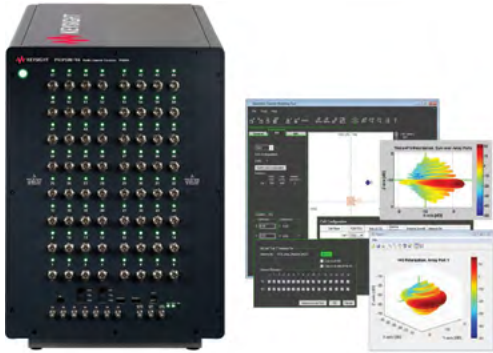

PROPSIM F64 5G Channel Emulation Solution

The PROPSIM 5G Channel Emulation Solution allows NEMs to validate new product releases and features. This solution tests the performance of 5G network equipment, including base stations and small cells. Users validate protocol layers and RF performance and gain access to key performance indicators. The PROPSIM solution covers beam management, data throughput, and stability under 5G fading channel conditions.

5G UE emulation for RAN and core testing

Keysight's 5G Edge to Core Solution emulates all the 5G and 4G network elements from UE and core networks. It enables complete and thorough isolation testing of individual nodes in the 5G networks by performing both functional and full-scale load testing with real subscriber modeling with IxLoad.



Keysight's 5G Edge to Core Solution

5G UE emulation for gNB validation

Keysight's UE Emulation Solution for gNB validation performs full-stack testing for LTE and 5G NR to verify RANs via both radio and O-RAN fronthaul interfaces. Fully scalable, it enables massive UE emulation to ensure functionality across all air interfaces. The solution supports both conducted and live testing across the full range of frequencies with the possibility to cover real-world scenarios spanning protocol and load testing from the lab to field testing, trials, and deployments.

5G core testing

Keysight's 5G Core Testing Solution validates critical 5G requirements for maximizing network reliability and performance. The solution scales up to millions of subscribers and performs comprehensive testing of all nodes and interfaces. It provides in-depth QoE statistics and metrics.

Multiport Device Testing Solution



M980xA Series PXIe Vector Network Analyzer

Keysight's PXI-based network analysis solutions, the M980xA PXIe VNA Series, enable engineers to drive down the size of the test setup and scale configurations as application needs change. It is also possible to cascade them into a multiport VNA with up to 50 ports in a single chassis. Component manufacturers can address different 5G massive MIMO antenna requirements using 17 two-port modules to create a 34-port VNA solution in a single chassis. Eight six-port modules and one two-port module provides 50 ports in a single chassis. To reach 66 ports, you need 11 six-port modules in two chassis.

5G Virtual Drive Testing Solution



Keysight's Virtual Drive Testing Toolset

Keysight's Virtual Drive Testing Toolset enables NEMs to conduct performance testing to achieve high confidence in their designs for a wide range of scenarios. This performance and interoperability testing solution brings real-world multipath propagation conditions in the laboratory enabling engineers to replicate complex 3D real-world radio channel conditions in drive or indoor test routes. It enables NEMs to assess the actual performance of network infrastructure equipment. Keysight's virtual drive testing solution accelerates product rollouts and quality assurance (QA) testing without compromising QoE.

5G Network Propagation Model Tuning Solution

Early 5G field measurements for path loss and link budget verification



Nemo Outdoor user interface

Keysight's 5G Field Measurement Solution is a complete system for early 5G NR radio propagation and coverage verification. These initial measurements give insights into 5G network propagation to create data useful for accurate network planning. Measurement data is imported to the planning tool to calibrate the propagation model and provide more precise coverage prediction results.



Keysight FieldFox handheld analyzer integrated with a phased array antenna

5G gNB field test

5G operators and NEMs will need new OTA test tools for network and UE field test, as well as optimization tools to deploy and verify the performance of these networks. Keysight's FieldFox handheld analyzer, combined with a phased array antenna, provides a unique, portable solution for measuring and analyzing the 5G air interface in the field.

5G Manufacturing Test Solutions



S9100A 5G Multiband Vector Transceiver

S9100A 5G Multiband Vector Transceiver

NEMs use Keysight's 5G manufacturing test reference solution for the fast and cost-effective testing of base stations and sub-assemblies in volume production. The solution performs wideband signal generation and analysis of 5G NR waveforms for radio units and antenna modules. It operates as a single instrument for easy automation and delivers exceptionally high test throughput.



Vector Network Analyzers

Performance PXI VNA

Keysight's network analysis solutions for manufacturing include the performance PXI VNAs and the ENA series. With Keysight's M980xA Series of PXI-based VNAs, component manufacturers can implement multisite configurations on top of multiport testing to optimize throughput. Since parallel testing increases throughput, it also reduces the cost of test. The ENA series enables manufacturers of passive components, SAW devices for mobile handsets, and general-purpose components such as antennas, filters, and cables to drive down the cost of test.

5G OTA Measurements

Keysight offers a portfolio of OTA solutions for FR1 and mmWave frequencies. A typical solution consists of measurement hardware and software, a network emulator to emulate the 5G gNB, and a channel emulator to imitate the radio conditions. RF enclosures, probe and link antennas, different DUT positioners, and associated control software complete the OTA test setup. Our solutions address the different test approaches, and the various requirements, across the workflow from R&D to device acceptance test.

Section 5

Accelerating 5G Network Commercialization



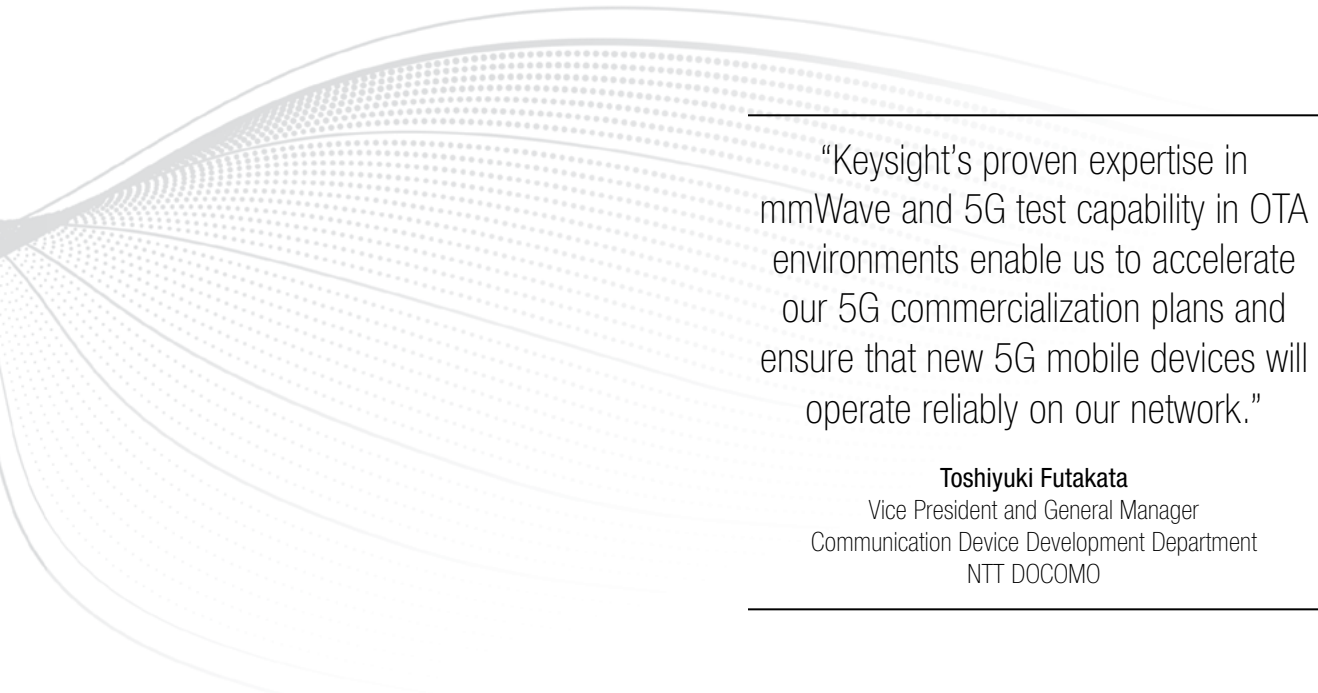

“Keysight’s proven expertise in mmWave and 5G test capability in OTA environments enable us to accelerate our 5G commercialization plans and ensure that new 5G mobile devices will operate reliably on our network.”

Toshiyuki Futakata

Vice President and General Manager
Communication Device Development Department
NTT DOCOMO

Chapter 22

5G Networking: An Overview

There are two main parts to the 5G system: wireless hardware and the network. The previous four sections of this book covered the wireless hardware part of the system — the physical layer that establishes the connection between the customer and the service provider. The second part of the 5G system is the network that provides the connections to other carriers and the internet. It is largely a software system. This section describes the 5G network and the test and measurement challenges it presents.

5G Core Service Based Architecture

The IMT-2020 use cases standardized through 3GPP rely on implementing a service-based architecture (SBA). The next-generation core implementation is fundamental to the commercial success of 5G. It enables new service types and benefits from cloud economics.

The major components of the 5GC network are:

- Authentication server function (AUSF) that authenticates UEs and stores authentication keys.
- Access and mobility management function (AMF) that manages UE registration and authentication (via AUSF) and identification (via UDM) and mobility. It also terminates NAS signaling.
- Network exposure function (NEF) that exposes capabilities and events. It stores the received information as structured data and exposes it to other network functions (NFs).
- Network repository function (NRF) that provides service discovery between individual NFs, maintaining profiles of NFs and their functions.
- Network slice selection function (NSSF) that selects the set of network slice instances serving the UE and determines which AMF to use.
- Policy control function (PCF) that provides policy rules to control plane functions.
- Session management function (SMF) that establishes and manages sessions (establish/modify/release). It also selects and controls the user plane function (UPF) and handles paging.
- Unified data management (UDM) that stores subscriber data and profiles. It generates the authentication vector.
- UPF is responsible for packet handling and forwarding, mobility anchor, and IP anchor towards the internet. It performs quality of service (QoS) enforcement.

There are two ways to represent the interaction between NFs when defining the 5G architecture as service-based. The reference point representation in Figure 22.1 shows the interaction between the NF described by a point-to-point reference point (e.g. N4) between any two network functions (e.g. SMF and UPF).

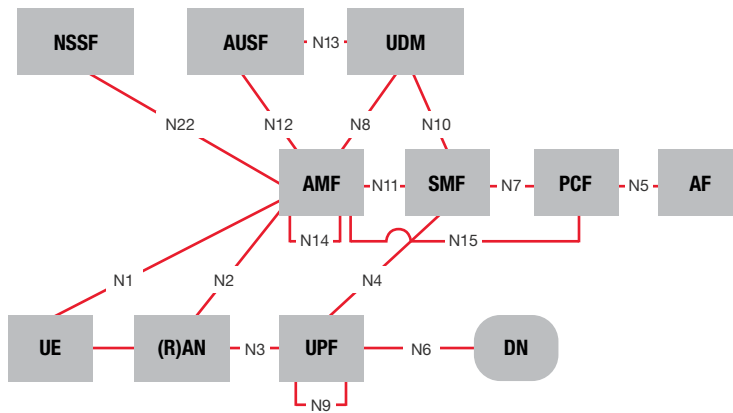

Figure 22.1. Reference point representation of the 5G system architecture

In the service-based representation, NFs (e.g., AMF) within the control plane enable other authorized NFs to access their services. See Figure 22.2.

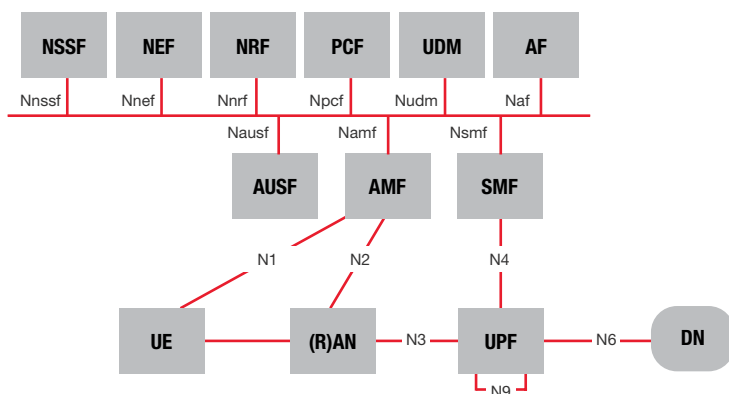

Figure 22.2. Service-based representation of the SBA architecture

The point-to-point architecture exists in previous generations (3G, 4G) with different NFs connecting over standardized interfaces. With the transition to a cloud infrastructure, the point-to-point model is no longer the best option. The challenge with the point-to-point architecture is that it contains many unique interfaces between various network elements creating dependencies between them. As a result, it is difficult to bring changes to the existing network. Engineers need to reconfigure or readjust multiple adjacent functions, which is difficult to achieve in a live network.

The SBA concept decouples the end-user service from the underlying network, enabling both functional and service agility. The SBA borrows many SBA aspects from software-defined network (SDN) technologies. NF services should be self-contained and reusable.

They also need to use management schemes independently from other services offered by the same NF (for scaling, healing, and other purposes). This new environment pushes companies to design cloud-native 5G core (5GC) functions or virtual network functions (VNFs). VNFs consist of disaggregated components (microservices) deployed in the cloud as workloads so that an orchestrator can scale them up or down, on-demand.

3GPP TS 23.501 specifies the following control plane interfaces in the 5G core network as service-based interfaces: Namf, Nsmf, Nudm, Nnrf, Nnssf, Nausf, Nnef, Nsmsg, Nudr, Npcf, N5g-eir, Naf. Service-based NFs communicate with each other using the HTTP 2.0 protocol. NFs play the roles of producer or consumer of services. Sometimes, they play both roles at the same time. A service consists of operations, based on either a request-response or a subscribe-notify model. For example, an NF requests a response from a producer about policy information while another NF subscribes to it to know when the UE status changes.

SBA, together with other concepts applied within the 5GC like network slicing, control user plane separation (CUPS), and edge computing, represent the fundamentals of the commercial success of 5G. These functions enable the delivery of various services across many vertical industries.

5G Network Challenges

5G provides significant revenue opportunities for mobile network operators. However, the plethora of use cases, network slicing, and the need for 5G to coexist with legacy technologies pose significant challenges. Engineers need to validate compliance with standards, regulations, and acceptance tests. They need to perform load testing at scale to verify the end-user experience, and verify network coverage in the constraints of accelerating timelines.

In the context of regulatory emissions standards, 3GPP standards, and carrier acceptance, network emulation is essential to simulate expected and worst-case scenarios. Functioning network equipment is fundamental to achieve a high quality of experience (QoE) for customers. However, diverse global spectrum requirements and the complexity of advanced 5G features are significant challenges. Engineers need to ensure RF and mmWave parametric performance of the radio and its protocol-driven functionality, which requires a high level of parametrization and automation.

Unprecedented traffic on mobile networks is looming with 5G. This traffic increase will have a significant impact on the network core and the RAN, requiring massive UE emulation with real-world conditions in terms of subscribers and applications. Mobile network operators need to also consider security issues and the dynamic nature, diversity, and complexity of mobility scenarios.

Mobile network operators face intense competition in 5G, and subscriber QoE is a significant competitive differentiator. In the 5G era, maximizing network coverage and uptime will be critical. Mobile network operators should ensure device and network interoperability before deployment, verify 5G radio propagation and coverage, and resolve unforeseen issues during deployment. They should also initiate a virtuous cycle for continuous customer experience improvement.

5G requires new technologies and performance improvements that challenge the way engineers test the network. MNOs face new application demands and need to find ways to support the massive increase in future subscribers. Meeting these requirements means that networks need to change to accommodate expanded frequencies in the mmWave spectrum, wider channel bandwidths, denser waveforms, and new user behaviors.

Keysight can help MNOs accelerate the delivery of secure, reliable, and cost-effective 5G networks and innovative services. Keysight delivers deep expertise in RF design and IP networking through an industry-leading integrated portfolio. Our solutions accurately emulate 5G devices, base stations, and massive subscriber behavior scenarios. Figure 22.3 summarizes the main test products of the Keysight portfolio from the lab to network deployment.

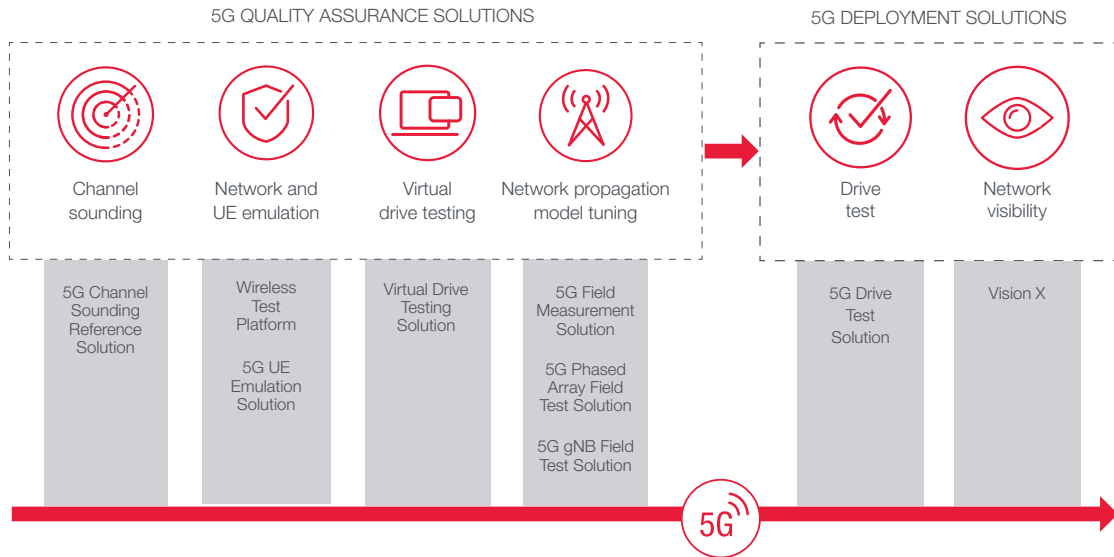

Figure 22.3. Keysight 5G solutions from laboratory testing to deployment

Chapter 23

Validating the 5G Core Network

MNOs are gearing up for the deployment of the most innovative wireless communication technology yet. 5G will enable them to bring new experiences to customers through virtual and augmented reality. It will give rise to amazing AR applications like remote surgery or machine-to-machine communication applications like the remote control of industrial machines.

Multiple migration paths are at the operators' disposal to evolve to 5G, including NSA and SA deployment options. A virtualized core network is important to achieve dynamic scalability. The packet core network architecture is changing radically to enable operators to deploy new resources in their networks flexibly. They are migrating from privately-owned data centers to cloud-native architectures, which are much more conducive to hybrid and public cloud deployments.

Succeed at 5GC implementation by:

1. Performing realistic testing
2. Testing nodes in isolation
3. Addressing network delay
4. Leveraging common measurement science
5. Adopting a holistic approach



Multi-access edge computing (MEC), SBA, and CUPS are other concepts MNOs can choose to implement. MEC enables off-loading traffic at the edge, saves network bandwidth, and makes achieving low-latency requirements possible. SBA and CUPS increase deployment flexibility and create new monetization opportunities.

MNOs face various choices, each translating into significant challenges for their engineers. They must understand the implications of their decisions and validate the resulting network changes to succeed in the 5GC network era.

5G is revolutionizing the mobile core network. MNOs need to virtualize their core networks and implement challenging concepts like MEC, SBA, and CUPS to achieve true elastic scalability and optimize costs. These technologies increase core network complexity exponentially. MNOs need to ensure traffic prioritization and QoS in a highly sophisticated environment. Succeed at core network testing in the 5G era with the following insights.

1. Perform Realistic Testing

The arrival of 5G brings a vast increase in network complexity. The number of connected devices will increase exponentially, and mobile data traffic is already growing at a double-digit rate, with a greater portion coming from video applications. Networks will also become denser, as Figure 23.1 illustrates.

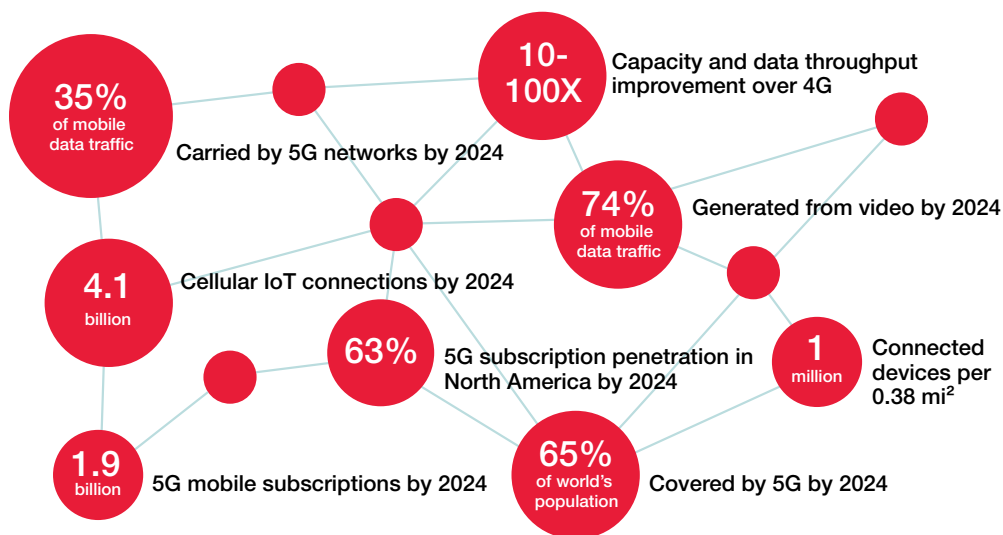

Figure 23.1. Why new 5G traffic is growing. Source: Ericsson Mobility Report, June 2019

Next-generation network nodes must be ready to handle more devices and latency-sensitive traffic. MNOs need to ensure traffic prioritization and QoS in a highly sophisticated environment. In this context, sending a dummy protocol is not enough to test the UPF. Pushing out line-rate throughput is not sufficient to validate the QoS implementation. You need traffic that is as realistic as possible to test, and throughput that reflects the network conditions. You must also consider real UE behavior.

To validate the 5GC network, laboratory engineers must emulate not only subscribers and their behavior, but also the services phones access, and the traffic running on top. This behavior needs replication in a realistic and full-protocol-stack way. Replicating real life in the laboratory is critical to:

- solve quality issues that cause potential outages
- conduct performance benchmarking to select the best network solutions for your network
- validate software updates from network vendors for a smooth rollout in production

It is important to remember that data sheets typically provide basic numbers determined in simple conditions. Engineers need to validate the data sheets provided by network vendors, including configuration options, scaling, and performance. For instance, MNOs must know the number of mobile subscribers a physical network element or VNF can support in their topology and network conditions. That number will vary depending on these factors. One thousand subscribers browsing the internet will have a lower impact on network equipment than if they perform calls and watch Netflix during their daily commute.

Using Keysight's IxLoad real-world subscriber modeling, engineers can develop realistic test scenarios for their core networks. From a single application, they can perform capacity tests, detail a device's throughput, measure voice and video quality, and model a wide variety of mobility scenarios. The solution features a topology-based user interface for comprehensive network re-creation in the laboratory. A multitude of test topologies are available — centered around node isolation, interface testing, or service validation. IxLoad is capable of simulating UEs over the radio and other core nodes or interfaces.

2. Test Nodes in Isolation

With 5G, core network complexity has reached a whole new level, prompting the move to test in isolation. By isolating nodes, engineers can test individual interfaces, nodes, or groups of nodes and entire functionalities across the 5GC in an end-to-end fashion.

Simulating UEs across multiple nodes is critical to validate functionalities and services. Key areas of focus include testing the UPF, AMF, SMF, and SBA nodes in different node-level scenarios as well as for performance.

When testing the UPF using a node isolation approach, the nodes run on both the control and user planes. The test tool simulates the gNB, SMF, and the data network (DN). Assessing UPF performance in a variety of scenarios is critical. Engineers need to validate KPIs per node and for multiple nodes. QoS validation is particularly important for the UPF.

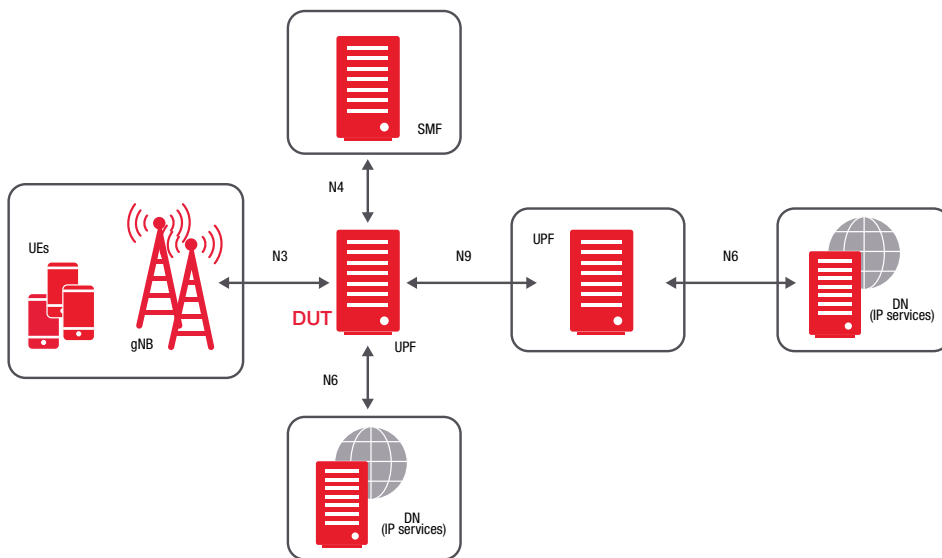

Figure 23.2. UPF isolation use case

For the AMF, the UEs send connection and session information over N1 and N2 interfaces. The AMF is responsible for handling connection and mobility management tasks. All messages related to session management are forwarded over the N11 reference interface through the SMF. When testing the AMF, the focus is on control plane functional and capacity testing. Testing the AMF in isolation requires testing coordination of the N1/N2 interfaces from the gNB and simulation of the SBA nodes. The AMF requires testing in different node-level scenarios and for performance.

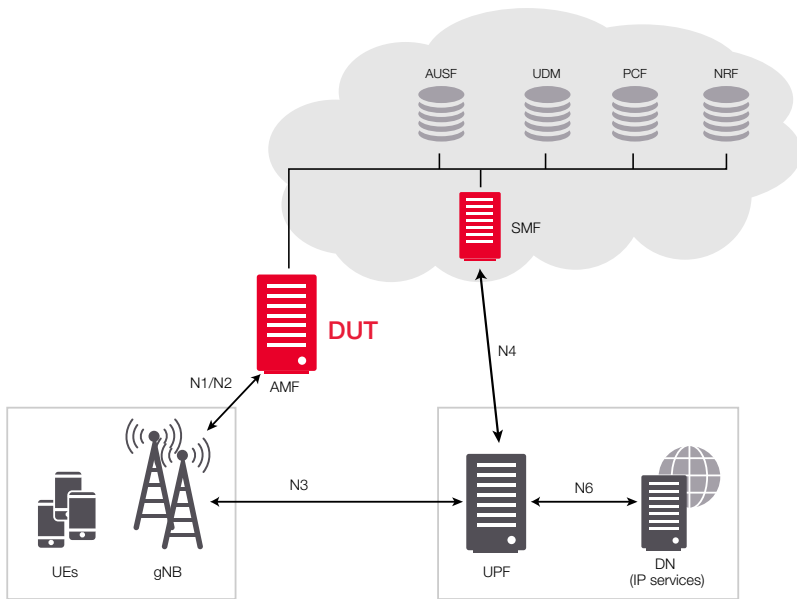

Figure 23.3. AMF isolation use case

Like UPF and AMF testing, testing the SBA nodes requires various node-level and performance test scenarios. At the node level, it is essential to test for registration to NRF, node failover, and elastic scaling. From a performance perspective, it is essential to validate the rate of various procedures for UE authentication and context management, as well as subscriber data management. SBA nodes have a dual role as producer and consumer. Validating both roles is essential.

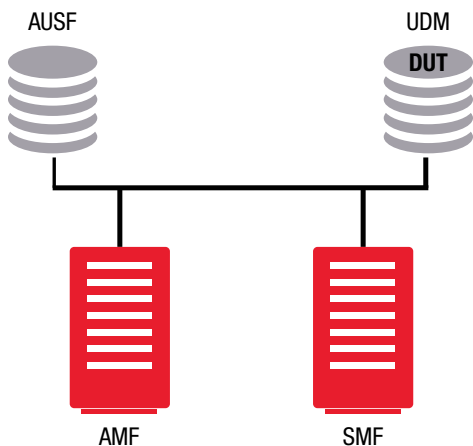

Figure 23.4. Example of SBA node isolation use case

3. Address Network Delay

The industry move towards virtualization enables the deployment of VNFs in public or private data centers. MNOs making this choice can achieve elastic scaling. For instance, operators might need to scale up capacity on a venue to provide bandwidth to hundreds of thousands of people attending a major sporting event. Instead of deploying trucks and equipment, they can rent out compute resources in a public cloud and deploy VNFs for a limited time. Using the cloud can generate significant cost savings for operators by eliminating CapEx in network equipment and the need to move that equipment when it is no longer required.

However, 5G applications like VR, AR, IIoT, autonomous driving, and remote surgery demand latency in the millisecond range. The transport network and the network nodes need to process and send the data packets across the network efficiently. Traffic offloading becomes important. QoS implementation and CUPS are also critical aspects to test and validate to reduce network delay.

The definition of QoS has evolved tremendously since the days of classic telephony, when it focused solely on connection requirements. Today, it ensures that certain packets take precedence by providing different levels of priority to applications, users, or data flows. QoS can also guarantee a certain level of performance to a data flow. QoS implementation for the core network is very different in 5G compared to 4G, with a move from evolved packet system (EPS) bearers to flows. There is a one-to-many relationship between the general packet radio services (GPRS) tunneling protocol user (GTPu) tunnel and the data rate bearers (DRBs) on the air interface. A QoS flow might map to one or more DRBs with additional ones allocated per network slice, multiplying the number of DRBs. 5G also introduces a new delay critical guaranteed bit rate (GBR) and the concept of a reflective QoS indicator (RQI). RQI enables the UE to map UL user plane traffic to QoS flows without SMS provided rules. These changes require thorough testing for successful deployment.

The nodes involved in controlling the QoS are the gNB, SMF, and UPF nodes. The SMF is responsible for session establishment and is also accountable for UE IP address allocation and management, configuring the traffic steering to route it to its intended destination, charging data collection, and providing support for charging interfaces. The UPF is responsible for QoS handling for the user plane, packet routing and forwarding, packet inspection and rule enforcement, as well as traffic counting and reporting. Using Keysight's 5G Core Testing Solution, engineers can validate critical 5G requirements to maximize network reliability and performance. They leverage the solution's built-in per UE detection mechanism to validate QoS enforcement at a high-performance level for the UPF.

4. Leverage Common Measurement Science

MNOs face a tremendous technology evolution with 5G. The current mobile packet core is transforming into the 5GC, an increasingly virtualized core network that utilizes challenging concepts like MEC, SBA, and CUPS. At the same time, operators are under extreme time and cost pressure to win the 5G race. They strive to reduce the product and service lifecycle. For example, they need to move away from the rigid, sequential waterfall model and adopt agile methods. It is possible to discover and fix issues in the production part of the lifecycle instead of sending products back to the laboratory.

However, many MNOs overlook the time-to-market advantages and cost efficiencies they could gain by adopting a common measurement science across the product/service lifecycle (see Figure 23.5). Most operators adopt a siloed approach to the testing and rollout of services, with dedicated teams for each phase — lab testing/pre-production and production. Having slightly different requirements, each team typically selects test equipment best-suited for their phase of the workflow. Different requirements lead to longer resolution times for issues found in the production stage of the lifecycle.

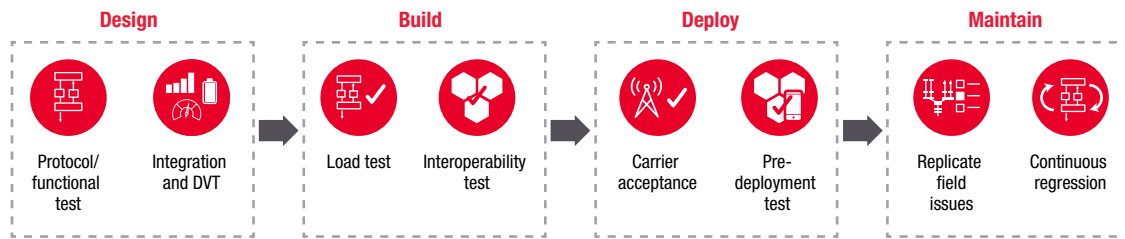

Figure 23.5. Typical product/service lifecycle at MNOs

MNO engineers need instruments tailored for each phase of the workflow to ensure measurement correlation. Keysight's 5G core test engine, for example, is used by carriers in the laboratory to perform trials and interoperability testing, validate network vendors' data sheets, build automation frameworks for the future, and validate cloud-native deployments via containers and microservices. It is also used in pre-deployment production testing to validate nodes and services in the production environment. The engine creates automated frameworks that typically integrate with the continuous integration/continuous delivery (CI/CD) ecosystem. Teams across the product/service lifecycle are familiar with the same test equipment and common measurement science resolves issues faster. Consistency in measurements also reduces the chance of errors, accelerates time to market, and reduces costs.

5. Adopt a Holistic Approach

New protocols are in use in the 5GC network, and the role of nodes has evolved. HTTP/2 has replaced diameter-based control protocols. Nodes interact in stateless mode and can produce, consume, or perform both functions at the same time. In the 5G era, the core network is built differently by various MNOs. It is no longer built in incremental steps, with months between the additions of nodes and interfaces. Since the 3GPP's Release 15 in December 2017, the industry must implement the entire core network at once.

Validating the 5GC network requires a holistic approach. MNOs need to start with simple scenarios by testing a node in isolation and build towards more complex ones. You can then see how the nodes interact with each other under stress or in the face of unexpected events. Keysight's 5G Core Testing Solution enables engineers to simulate multiple nodes and interfaces simultaneously to recreate entire networks in their laboratories (see screenshot in Figure 23.6).

Partnering with an expert in core network testing helps accelerate time to market to ensure deployment success. Keysight has developed a broad range of use cases for the 5GC, including gNB simulation, AMF and SMF isolation, SBA nodes isolation, and AMF isolation. Upcoming use cases addressing network slicing, the uplink classifier (UPCL) at the UPF level, and traffic steering will enable operators to test or emulate any signal network element or function in the 5G core end-to-end.

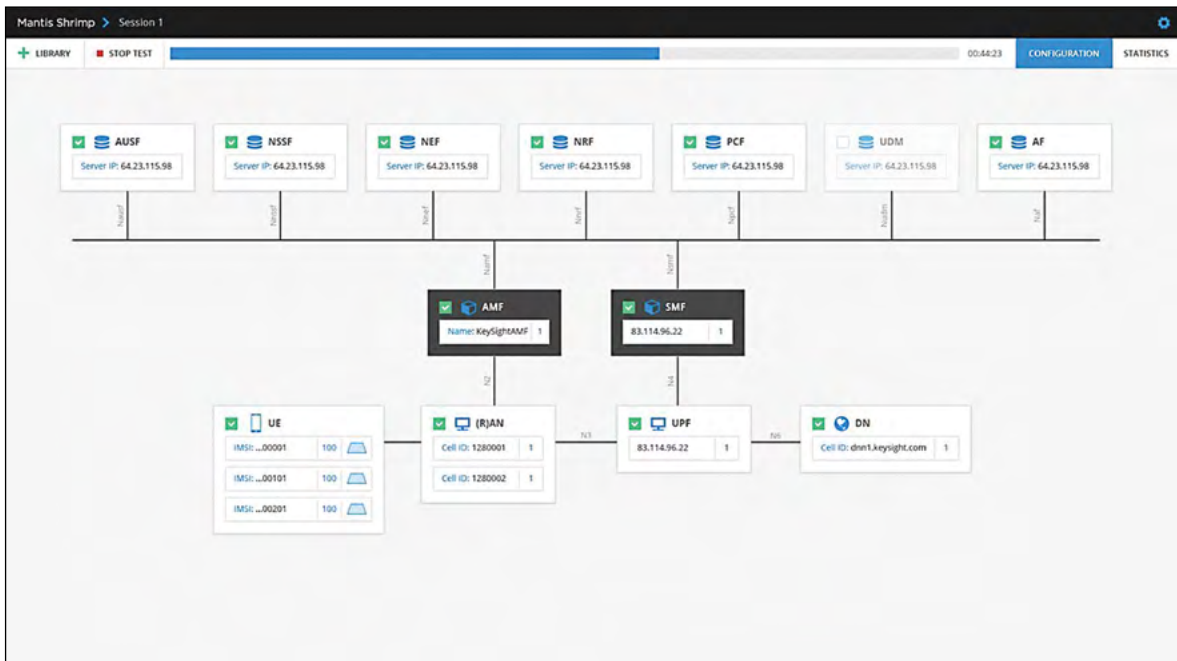

Figure 23.6. Software helps visualize the core network architecture

Chapter 24 Redefining 5G NR Field Testing

Live network testing is needed to ensure beams transmit accurately and to achieve throughput per cell and device as well as QoE metrics. 5G NR deployments are planned predominantly in the 3.5 GHz and 28 to 29 GHz frequency ranges. Both frequency ranges are new to the cellular network and require changes in radio access techniques and network architecture.

Massive MIMO with beamforming will be used to achieve higher network capacity and higher data throughputs in these new frequency bands. Using these technologies, however, changes the radio access from cell coverage to beam coverage, representing a significant change from 4G RANs.

5G NR also introduces a flexible air interface to support the many different types of services expected with 5G. The backhaul infrastructure must be flexible to handle the many different types of devices and varied traffic loads. Many operators are moving to SDN and network function virtualization.

Distributed cloud, network slicing, and self-optimizing networks are key enabling technologies. These technologies help virtualize the network architecture and management plane to create enhanced communication capabilities. However, this also means new tests are required to optimize QoE for different 5G applications.

Overcome 5G field testing challenges by:

1. Reconsidering scanners and test UE setups
2. Distributing test UEs when testing for capacity gain
3. Using both scanners and UEs
4. Performing active testing with real OTT applications

1. Reconsider Scanners and Test UE Setups

Network coverage measurements are different in 5G NR compared to LTE. 5G NR uses different forms of MIMO and beam steering to improve performance, which results in beam-based coverage instead of cell-based coverage.

Massive MIMO will be used below 6 GHz using many more antennas on the base station configured as multi-user MIMO (MU-MIMO). MU-MIMO systems send multiple data streams using the same time-frequency resources from the base station. Using the massive number of antennas improves MU-MIMO performance, increasing total cell capacity.

With the use of MIMO and beamforming, there is no cell-level reference channel from where to measure the coverage of the cell. Instead, each cell has one or more synchronization signal block (SSB) beams, as shown in Figure 24.1. The maximum number of SSB beams per cell is between four and 64, depending on the frequency range. SSB beams are static or semi-static, always pointing in the same direction. They form a grid of beams covering the whole cell area. The UE searches for and measures the beams, maintaining a set of candidate beams. The candidate set of beams may contain beams from multiple cells. The key metrics measured are reference signal received power (SS-RSRP), reference signal received quality (SS-RSRQ), and signal-to-interference-plus-noise ratio (SS-SINR) for each beam. In field measurements, these metrics can be collected both with scanning receivers and test UEs.

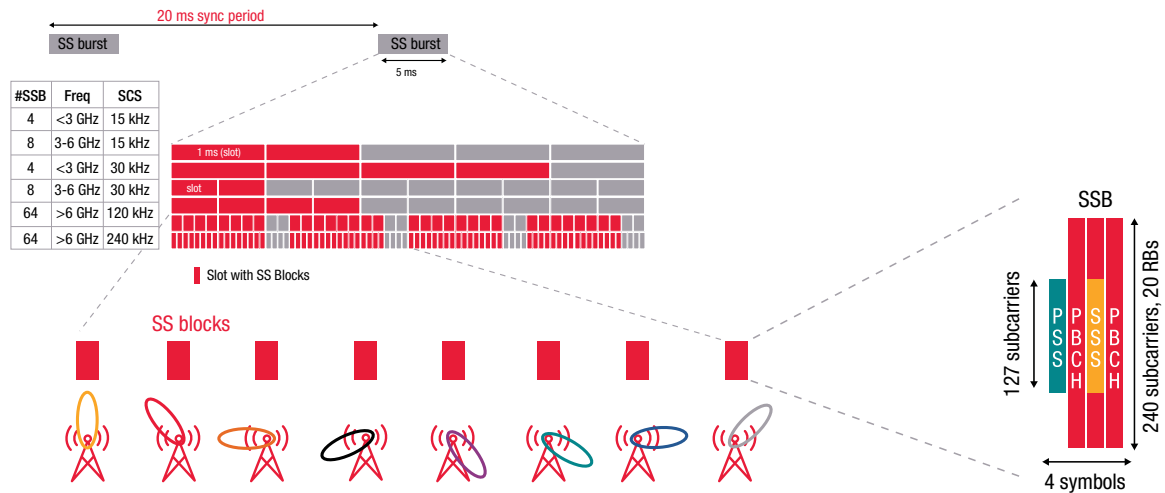

Figure 24.1. Slot structure of SSBs mapped to a grid of static or semi-static SSB beams

The different SSB beams of a cell are transmitted at different times resulting in no intracell interference among the SSB beams. Therefore, scanning receivers should be able to detect extremely weak SSB beams, even in the presence of a dominant, strong beam from the same cell. In general, the number of reference signals in the air will increase. As an example, imagine a place of poor coverage in an LTE network, where a scanner or a test UE detects reference signals from six different cells. If it were a 5G NR network, the device could see, for example, six beams of each six cells, for a total of 36 reference signals.

2. Distribute Test UEs When Testing for Capacity Gain

Massive MIMO is a cell capacity feature for sub-6 GHz 5G NR. The performance of a massive MIMO implementation has a major impact on the system capacity of the 5G NR network. Massive MIMO is one of the best areas where network equipment manufacturers can differentiate themselves from competitors. Verifying the field performance of massive MIMO implementations as part of the vendor selection and network acceptance processes is critical.

To achieve massive MIMO capacity gain, multiple UEs must generate downlink traffic simultaneously. Many variables impact the actual gain provided by massive MIMO. The spatial distribution of UEs has a big impact. Ideally, the UEs are scattered across the cell area. If all users are packed in the same location, it becomes impossible to isolate the users to different non-overlapping beams. The minimum acceptable horizontal and vertical spatial separation between UEs may differ depending on the number of physical antenna elements in the gNB antenna panel in the horizontal and vertical dimensions. The SNR of each user, as well as the multipath propagation profile, impact the achievable performance. The scheduling decisions, as well as whether to use MU-MIMO or not, are made every 1 ms (slot) by the gNB.

When testing the capacity gain of massive MIMO, there need to be multiple test UEs distributed in the cell area, each performing simultaneous active bulk data transfer against a test server. As part of a test setup, it is important to ensure that the core network and backend server have sufficient bandwidth so that the radio interface is the only bandwidth bottleneck during the test. Multithreaded data downloads can be used in the tests to remove the negative effects of transmission control protocol (TCP) flow control. Different test scenarios include UEs close to each other to test the threshold for spatial separation where massive MIMO can still provide gain, vertical distribution of UEs (e.g., one on each floor of a high-rise building), horizontal distribution of UEs, line-of-sight UEs vs non-line-of-sight UEs with rich multipath propagation environment, cell edge vs cell center, moving UEs, or any combination of the above.

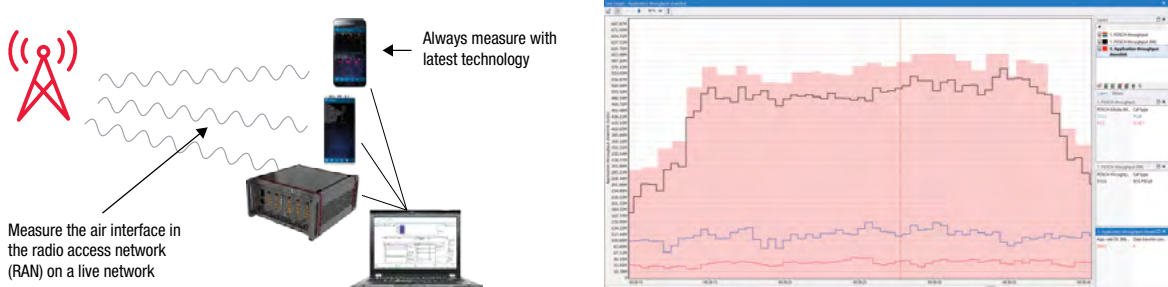

Figure 24.2. 5G NR-ready testing solution for massive MIMO with post-processing example showing throughput

A measurement solution consists of field test units with form factors ranging from scanners, a single UE terminal, to a PC-controlled chassis housing multiple test UEs performing drive test or walk test (Figure 24.2). Test solutions need to have the ability to monitor the data live or to take the data captured back to the lab for post-processing. Post-processing of the data enables a deeper analysis to find blind spots, pilot pollution, spillage, and other coverage issues. With post-processing, it is possible to calculate other cell-level KPIs like cell throughput.

3. Use Both Scanners and UEs

Both scanners and test UEs are available for 5G NR field testing. In legacy systems, scanners were best suited for coverage measurements because they measured all cells from all networks in one instance. Scanners scan the network and test for in-band and out-of-band interference. A UE is always tied to one operator and does not necessarily measure all technologies or even all carriers, as it is limited by the neighbor list definitions in the network. In 5G NR, scanners measure the SSB beams — primary synchronization signal (PSS), secondary synchronization signal (SSS), and physical layer broadcast channel (PBCH). These are the basic coverage measurements of the 5G NR network. Figure 24.3 shows an example.



Figure 24.3. Example 5G NR scanner measurements showing coverage and quality metrics including SS-RSRP, SS-SINR per each SSB reference beam of a cell

However, there are a few differences in using scanners in 5G NR compared to legacy technologies. In wideband code division multiple access (WCDMA) and LTE networks, scanners can read the full system information, including global cell ID, mobile network code (MNC), mobile country code (MCC), and other useful network parameters. In 5G NR, the common PBCH that is part of the SSB block broadcasts only the bare minimum system information. The minimal broadcasts avoid common, always-on, cell-level transfer and minimize the energy consumption of the network. The rest of the system information is sent to the UE on demand at the time a connection is established. As a result, 5G NR scanners cannot read the full system information from the cells they scan.

Another consideration is that the scanner antennas have different characteristics than mobile UE antennas. These differences were a consideration in LTE, along with the MIMO antennas, and are even more important in 5G NR. With the first 5G NR UEs introduced in 2019, coarse beamforming is being implemented in the device end as well. This means that antenna gain and MIMO performance will be even more dependent on the devices.

Therefore, most live network testing requires the use of both scanners and candidate UEs. Scanners will capture the SSB reference beam coverage and provide agnostic coverage measurements. UE terminals validate performance for dual connectivity and UE mobility, including beam switching and handovers between cells.

4. Perform Active Testing with Real OTT Applications

Network slicing is a new concept in 5G NR for both the core network and RAN. Network slicing allows the creation of multiple virtual networks on top of a common shared physical infrastructure. A single physical network is sliced into multiple virtual networks that support different RANs, or different service types running across a single RAN. Network slicing replaces the QoS profiles used in LTE and universal mobile telecommunications. One big difference from the legacy technology is that the network will automatically detect the type of application. As a result, the network can apply different QoS settings for different applications. For example, the network could detect a WhatsApp call to be a voice over IP (VoIP) service and relay the traffic on a network slice optimized for low latency, guaranteed low bitrate traffic.

A 5G NR network with network slicing operates differently depending on the application used by the subscriber. Making bulk data transfers using FTP or speedtest.net will not give an accurate picture of the true QoE. Therefore, active QoE testing using real applications will be increasingly important in 5G NR. Operators will need to do network optimization or network benchmarking with live applications to find out where issues might occur.

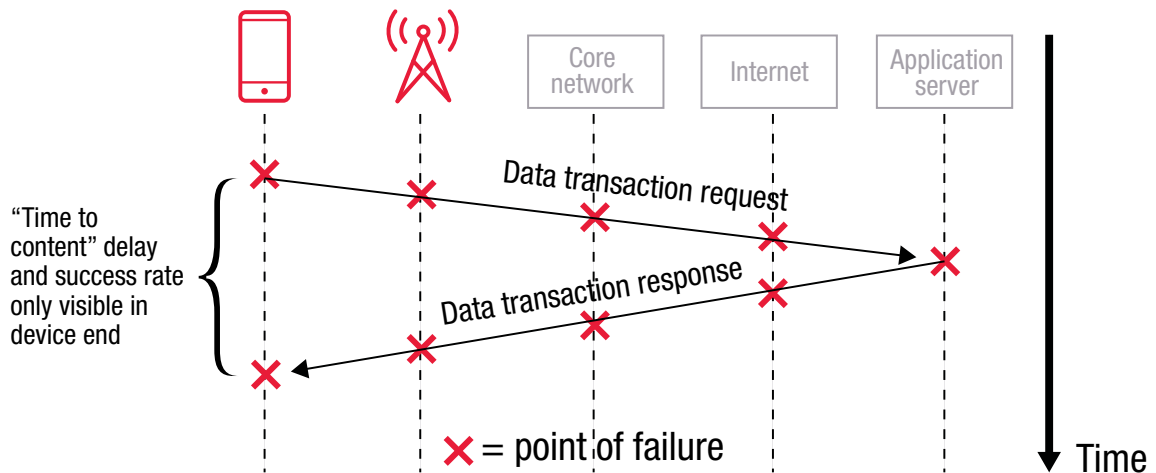

Figure 24.4. Identifying points of failure with 5G NR end-to-end QoE field test

The only way to accurately assess end-to-end QoE in 5G NR is by using active tests conducted at the device end, as shown in Figure 24.4. The three important, measurable KPIs related to the QoE of any transaction (accessibility, retainability, and time-to-content) are only visible and measurable at the device end by active tests using real over-the-top (OTT) applications.

It is important to test the latency and peak throughput of the connection, including root cause analysis that will identify where the bottleneck of the connection is: device end, last-mile (RAN), core, or backend server. As a result, you can pinpoint points of failure for dropped calls or handover issues. New test schemes require QoS predictions on a mean opinion score (MOS) scale for different application types, including VoIP, streaming video, live TV, and web browsing. These test schemes provide a quick check of the 5G NR end-to-end performance with different types of applications without the need to check the QoE by application.

Field testing (drive testing) at the application layer can translate the user experience into measurable KPIs and speed up the field verification of the 5G NR use case.



Chapter 25 Spotlight on Over-The-Air Performance Testing

To achieve 5G goals for massive capacity, super-fast data rates, and ultra-low latency, network and user equipment manufacturers must invent technologies to make the network drastically more efficient. They must also deploy a new spectrum to support much wider bandwidth requirements. 5G requires three key technologies: mmWave network deployment, massive MIMO, and beamforming. It presents uncharted territory for RF engineers in terms of how to characterize a mmWave air interface, measure antenna efficiency, determine potential interference issues in these networks, and create methods for evaluating 5G trial networks over the air.

mmWave Band for 5G Deployment

LTE with 20 MHz bandwidth and 64 QAM can achieve a 100 Mbps data rate on the downlink. However, for 5G to provide 100x higher data rates, it will require much wider bandwidths. The current sub-3 GHz cellular band cannot support wider bandwidths. The only way to implement 5G is to move the system to a higher frequency band.

5G requires a much higher bandwidth; as much as 800 MHz to 2 GHz. The frequency bands that have such potential are mmWave bands. The deployment of satellite communication in the Ka-band (26.5 GHz to 40 GHz) increased channel bandwidth — from a typical bandwidth of 54 MHz to 500 MHz through 2 GHz — and was accompanied with spot beam frequency reuse to achieve gigabit IP connection.

In October 2015, the Federal Communications Commission (FCC) allocated three mmWave bands for 5G services; these bands are the frontier spectrum for 5G services. Spectrum above 24 GHz is currently under investigation. The 28 GHz band supports 850 MHz of bandwidth, and the 37-40 GHz band supports 3 GHz of bandwidth. An unlicensed band from 64–71 GHz supports 7 GHz of bandwidth. These spectrum and bandwidth allocations make the 5G service possible. Figure 25.1 shows the 5G bands.

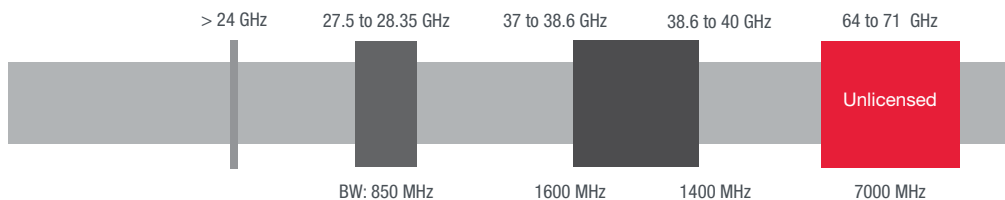

Figure 25.1. FCC 5G frontier bands

mmWave Link Propagation and Link Budget

Commercial wireless service frequencies are below 6 GHz, including Wi-Fi. The channel characteristics of these bands are well understood, with many design tools available to use. However, deploying mmWave frequency bands to provide a link between the UE and base station presents many technical challenges. It is essential to understand mmWave path loss properties and build a predictable mathematical model. The mmWave signals are particularly vulnerable to obstacles of any type (see Figure 25.2).

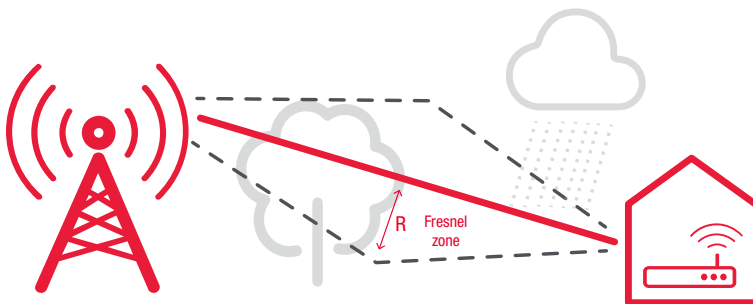

Figure 25.2. Various factors affect 5G radio received signal level

Path loss and link budget are two essential elements in investigating 5G link behavior. 5G links include line of sight (LOS) and non-line of sight (NLOS) components in the radio propagation environment. LOS is close — but not exact at above 60 GHz — to free space path loss, whereas NLOS path loss deviates significantly from free space. The typical process is to make a propagation loss measurement at a specific frequency and terrain. You can then perform a curve fitting to find the loss of exponent n . The combined path loss is proportional to the distance between transmit and receive antenna n — where n is the loss of the exponent, which can range from 2–4.

Free space path loss = $(4\pi d/\lambda)^2$ (d: distance; λ : wavelength)

Free space path loss in dB = 92.45 + 20 log (distance in km) + 20 log (frequency in GHz)

Point-to-point microwave communications require a clearance between the propagation path and the nearest obstacles on the ground, which is governed by the Fresnel zone theory. If the zone is 60% clear, it is LOS propagation. 5G networks, however, will have much lower antenna height, which could potentially introduce significant propagation blockage.

5G mmWave link budget is quite different from the traditional sub-6 GHz wireless link budget. It can cause further losses due to rain fade, shadowing loss, foliage, atmosphere absorption, humidity, and Fresnel blockage.

Below is an example calculation of the 5G link budget that could vary depending on the band and type of cell:

Received power in dBm = Tx power + Tx antenna gain + Rx antenna gain - path loss

- **Rain fade (2 dB/200m) - shadowing loss (20 to 30 dB) - foliage loss (10 to 50 dB)**
- **Atmosphere absorption - terrain/humidity - Fresnel blockage - system margin**

Fresnel zone radius (R) = $17.32 \times \sqrt{(d/f)}$ (d in km, f in GHz)

Examining the above equations illustrates that many factors can impact mmWave links. The link budget is the most critical area of focus for any 5G deployment team.

Propagation Loss Measurements with FieldFox

You can use Keysight's FieldFox handheld microwave analyzer to measure propagation loss. The FieldFox has an operating mode known as extended range transmission analysis (ERTA). ERTA requires a connection between two FieldFox instruments, with one acting as the transmitter and the other as the receiver. Triggers on each box synchronize the measurement. An Ethernet connection sets the frequency range and transfers the results from the transmitter to the receiver (the receiver is always the master in this setup). The splitter at the transmitter side measures the output power from the transmitter, so the receiver side knows the exact transmitting power level. FieldFox can record real-time data, replay the data, and then export it for post-analysis.

When longer distances are necessary for the measurement and physical cable connections are no longer viable, then an external laptop controls both FieldFox instruments. You can implement a software trigger to reduce the speed to perform the ERTA measurement.

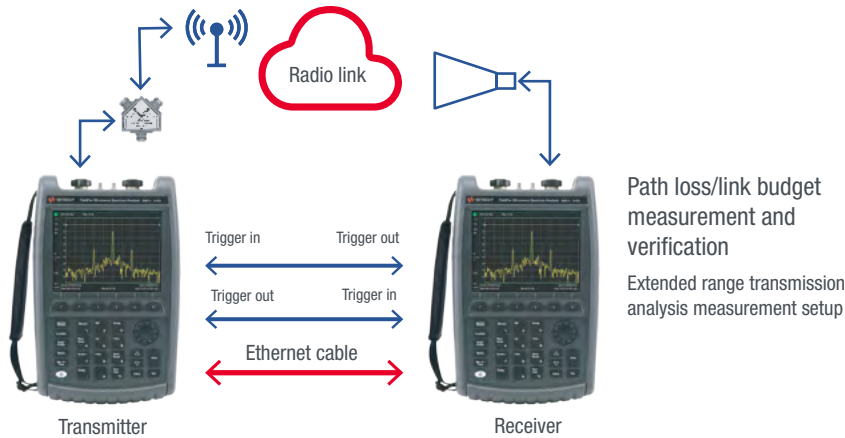

Figure 25.3. ERTA setup for propagation loss measurement

Massive MIMO

Massive MIMO is an extension of MU-MIMO; the number of base station antennas is much higher than the number of UEs in the cell. The average number of antennas is 48 to 64. The increase in the number of antennas makes the beam much narrower to allow the base station to deliver RF energy to the UE more precisely and efficiently.

You can control the antenna's phase and gain individually; the channel information remains with the base station. This type of implementation simplifies UE design without adding multiple receiver antennas. Installation of a large number of base station antennas will increase the SNR in the cell, which leads to higher cell site capacity and throughput. As 5G massive MIMO implementation is on mmWave, the antenna is small and easy to install and maintain. Figure 25.4 shows the operational process.

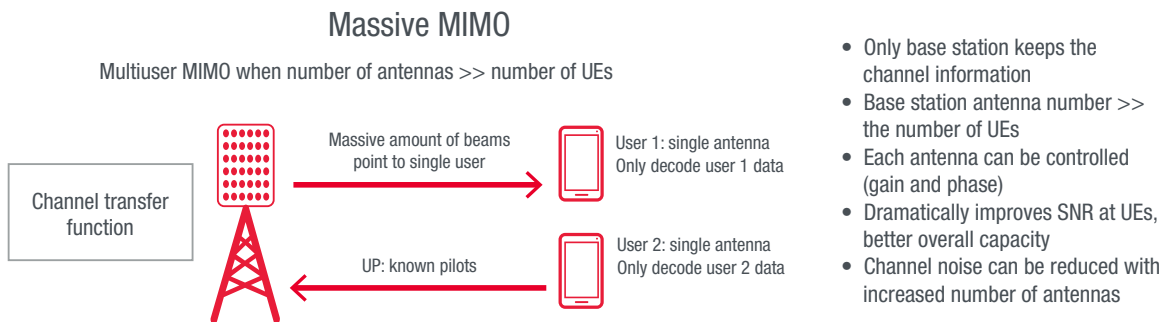

Figure 25.4. Massive MIMO operation principle

Beamforming

You can control the element of a phased array antenna through beamforming. Beamforming is crucial to the success of 5G networks, offering better efficiency to overcome path loss, channel noise, and channel crosstalk. At mmWave, the path loss is much more significant than at sub-6 GHz.

Figure 25.5 shows how beamforming works. On the left side, the delay between two-phased elements is 0. The wave travels straight. When adding delay, the wave changes direction. The base station can steer multiple beams to multiple UEs simultaneously when controlling the individual array antenna.

5G beamforming has three stages: beam acquisition, feedback, and change. In the beam acquisition phase, the base station does a beam sweep, sending out a beam to eight different directions in one symbol. The UE detects the best beam and transmits the random access channel (RACH) to the base station (see Figure 25.6). In feedback and change stages, the UE sends the ranking list of beams to the base station, and the best possible beam steers toward the UE. Lastly, during data transfer, the UE can continuously provide feedback to the base station to make small adjustments to the beam to achieve a better SNR. Figure 25.7 shows the beamforming apparatus in a highly simplified form.

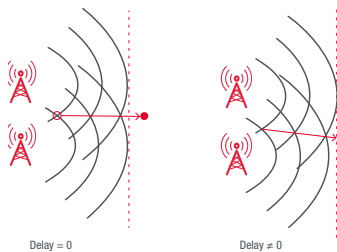

Figure 25.5.
How beamforming works

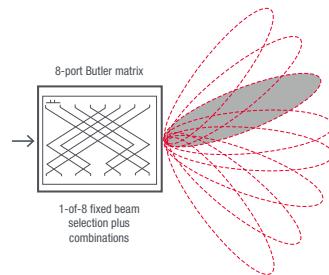

Figure 25.6.
5G beam acquisition and
feedback

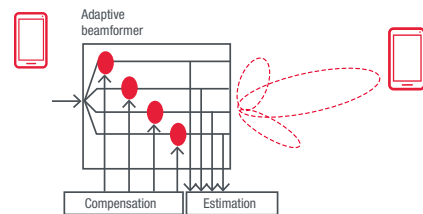

Figure 25.7.
5G beam change

5G mmWave Coverage Verification

mmWave band adoption is critical for 5G implementation. mmWave frequencies allow the network to provide much faster data rates and precise sensing networks for IoT. A typical network deployment begins with network planning. Engineers use RF network planning software to design 5G networks based on both site survey data and link budget assumptions. Since the design does not match the real performance of the network in most cases, verification and optimization are essential after installation. The problem of matching the real performance of the network is particularly acute for mmWave 5G networks.

The first step is to verify that the network does not have any coverage gaps. You can perform this check by measuring the coverage against the network design. For sub-3 GHz networks like LTE, engineers use scanning receivers with omnidirectional antennas that match UE antenna characteristics to measure signal strength and control channel power from the base stations. Because the omnidirectional antenna receives energy from all directions, this is the best method to perform network coverage testing.

However, using omnidirectional antennas as receiving antennas is no longer feasible in a 5G mmWave network because the:

- 5G UE antenna is a phased array antenna
- 5G mmWave gNB antenna is a phased array antenna with beamforming
- UE can only use a particular set of multipath signals; the omnidirectional antenna is no longer representing UE RF reception performance

An innovative approach is necessary to create an actual 5G mmWave network coverage test. Instead of using an omnidirectional antenna, a phased array antenna with a spectrum analyzer or scanning receiver is necessary to measure network coverage. The phased array antenna-based coverage measurement system can steer measuring beams to:

- evaluate beam power from the gNB to calculate network coverage
- conduct multipath impact evaluation
- simulate UE antenna performance to estimate potential UE coverage issues

By changing the beam width, the phased array antenna is configurable as an RF probe to measure gNB parametric performance over-the-air. In a typical LTE coverage test, the omnidirectional antenna-based measurement receiver takes one data point per geolocation. You can generate many samples at the location to achieve a better statistical value of the power level.

In contrast, the 5G mmWave requires geolocation, azimuth, and elevation to represent each data point. This requirement creates tremendous challenges for RF engineers to perform the network test. There are only a few systems available that can make such measurements. Keysight's FieldFox analyzer is equipped with a spectrum analyzer and integrates an 8x8 phased array antenna to enable 5G coverage testing. The instrument controls the measuring beam to sweep from 0 to 120 degrees in azimuth and 0 to 90 degrees in elevation. The generated heat map shows the coverage in any location. You can log the data with geotags and export to any network planning tools to facilitate beam optimization.



Figure 25.8. FieldFox phased array antenna coverage test system



Figure 25.9. Polar scan

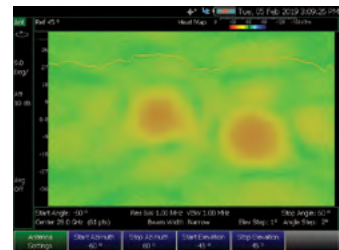

Figure 25.10. 2D scan heat map – azimuth vs. elevation

Phased Array Antenna Pattern and Phase Delay Test

Because a 5G base station radio and its phased array antenna integrate into a single hardware unit, there is no RF connector at the antenna to allow test equipment to measure return loss and voltage standing wave ratio (VSWR). However, it is necessary to know the performance of the antenna. Since antenna beam width from a mmWave phased array antenna is very narrow, it is possible to steer energy from it toward an over-the-air coupling probe. The spectrum analyzer measures the antenna pattern of the array and the isolation between the main lobe and sidelobe.

Figure 25.11 shows how the spectrum analyzer is configurable to verify the antenna pattern. The spectrum analyzer configures as a zero span. Set sweep time long enough to synchronize to the rotation of the golden antenna.

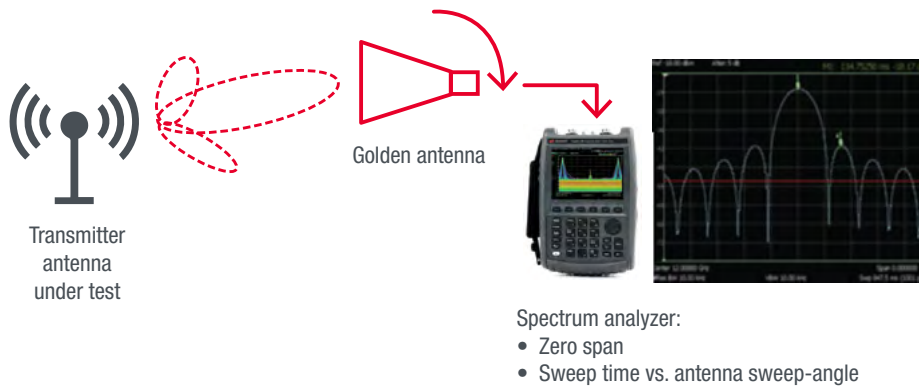

Figure 25.11. Antenna pattern verification using a FieldFox spectrum analyzer

A 5G phased array antenna has many elements; 64/128/256. Each element's phase is adjustable. It is important to know whether the adjustment can translate into phase shift over-the-air.

A network analyzer with a vector voltmeter (VVM) measures the phase shift between two receiving ports. Choose one of the elements as a reference and connect it to port 1 — that connection can be via an antenna probe. Port 2 is attached to the element under test. The VVM reports the delta of phase and magnitude between the two elements. The delta phase is the phase adjustment of the phased array antenna.

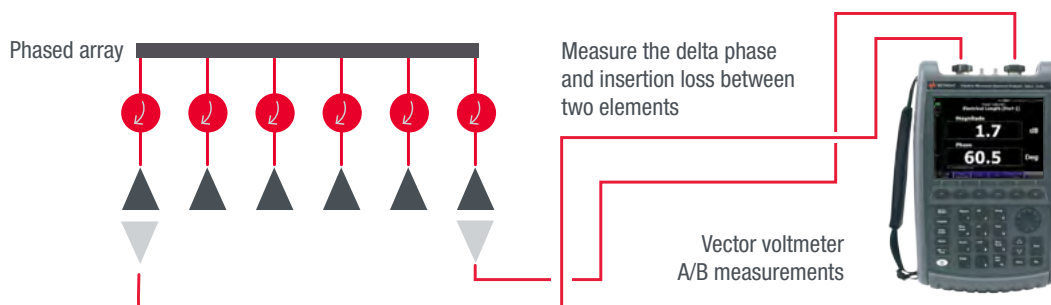

Figure 25.12. Using a VVM to characterize phased array antenna

FieldFox Microwave Analyzer Helps to Fast-Track 5G Deployment

The FieldFox microwave analyzer integrates many key mmWave tests into one package to enable 5G pre-deployment tests and ongoing maintenance. Since 5G is still in the development stage, the technology will change along with standardization development. Therefore, additional new tests are necessary. FieldFox is a software-defined instrument — all measurement capabilities are via software licenses, except for frequency.

FieldFox (shown in Figure 25.13) can perform many 5G necessary tests during the deployment stage. Here is a partial list of features:

- frequency coverage: 9 kHz to 32/44/50 GHz
- spectrum analysis
- phased array antenna beam scanning
- interference analyzer with record and playback
- built-in mmWave continuous wave independent source
- real-time spectrum analyzer with record and playback
- channel scanner with google map file format (CSV/KML) support
- built-in power meter
- extended range transmission analysis
- vector voltmeter
- cable and antenna analyzer
- vector network analyzer

Also, FieldFox has a rugged design and is battery-powered. It has no fans or vents, operates from -10 °C to +55 °C, and meets the IP53 standard.

Deploying 5G on mmWave presents many challenges to RF engineers. It is essential to have a robust channel model for 5G mmWave frequencies. Massive MIMO and beamforming are an integral part of 5G, and early extensive tests are necessary to enable deployment. Keysight's FieldFox analyzer provides propagation loss test, antenna pattern over-the-air test, phased array antenna-based measurement system, and many other standard mmWave tests in a single instrument. It greatly improves the efficiency in 5G pre-deployment, first-office applications, and ongoing maintenance.



Figure 25.13. FieldFox unit



Chapter 26 Solutions for Designing and Deploying 5G Networks

The complexity of 5G, increasing user demands, and the hypercompetitive nature of the commercial wireless communications industry make it critical for mobile network operators to validate the performance of networks and UE. At the onset of the 5G mobile network rollout, a top priority for MNOs is to understand network coverage and identify issues with 5G networks.

“China Telecom is actively promoting the commercial deployment of 5G technology. Leveraging Keysight’s 5G network emulation solutions will enable us to greatly accelerate the development and deployment of our 5G technology and establish a leadership position in the industry.”

Baorong Li
General Manager of Terminal R&D Center of Guangdong Research Institute, China Telecom Co., Ltd.

Keysight's collaborations across the mobile ecosystem give mobile network operators a heads-up on the upcoming 5G rollout and network optimization challenges. With Keysight's solutions, mobile network operators can evaluate device protocol compliance and perform realistic large-scale UE simulation thoroughly and efficiently. Keysight's deployment solutions are available in different form factors and enable MNOs to accurately test the network in a variety of use cases and launch 5G services rapidly and successfully.

5G Channel Sounding Solution

Keysight's 5G Channel Sounding Reference Solution consists of multiple hardware and software elements to provide wideband signal generation. This solution helps research engineers advance 5G channel modeling at mmWave frequencies.

The test platform addresses the challenges posed by mmWave frequencies and wide analysis bandwidths for 5G channel capture and characterization. Researchers can determine the properties of a radio channel by understanding the impact of path loss, Doppler effect, and other issues on signal transmission. The solution easily scales up by adding Keysight up/down converters and digitizers.

5G Network and UE Emulation Solutions



E7515B UXM 5G Wireless Test Platform

Keysight's 5G network emulation solutions, based on the E7515B UXM 5G Wireless Test Platform, enable mobile network operators to evaluate device compliance against standards and regulations and their acceptance tests. These solutions comply with the 3GPP Release15 standard, allowing mobile operators and their 5G mobile device suppliers to address new technical challenges and accelerate deployment of 5G technology across sub-6 GHz and mmWave frequencies.

By partnering early with leading chipset and device manufacturers, Keysight introduced 5G network emulation solutions for both protocol testing and RF performance validation. Mobile operators around the world use Keysight's network emulation solutions as part of their mobile device acceptance plans.

5G UE emulation solutions



Keysight's 5G Edge to Core Solution

Keysight's 5G Edge to Core Solution emulates all the 5G and 4G network elements from UE and core networks. End-to-end testing encompassing both RAN and core can involve both functional and full-scale load testing. Using IxLoad, it simulates stateful UE behavior at scale with real-world scenarios including real subscriber modeling.

5G UE emulation

Designed for multi-standard end-to-end mobile network verification, Keysight's UE Emulation Solution enables operators to validate complex network environments by emulating real network traffic over both the radio and the O-RAN fronthaul interfaces. Operators achieve thorough validation using real-world scenarios by verifying functionality across all air interfaces, and recreating traffic surges similar to those generated by a variety of real smartphones and applications.

5G core testing

Keysight's 5G Core Testing Solution validates critical 5G requirements to maximize network reliability and performance. The solution scales up to millions of subscribers and performs comprehensive testing of all nodes and interfaces, providing in-depth QoE statistics and metrics.

5G Virtual Drive Testing Solution



Keysight's Virtual Drive Testing Toolset

Keysight's Virtual Drive Testing Toolset leverages Keysight's PROPSIM 5G Channel Emulation Solution, 5G Network Emulation or real network infrastructure, and Nemo field measurement solutions. It enables mobile network operators to thoroughly verify end-user experience by replicating and repeating virtual drive testing scenarios in a controlled environment.

5G Network Propagation Model Tuning Solution

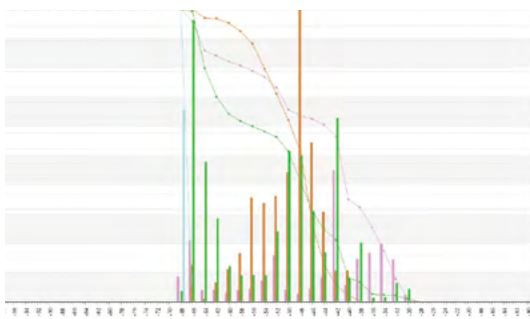

Keysight's 5G Field Measurement Solution

Keysight's 5G Field Measurement Solution is a complete system for early 5G NR radio propagation and coverage verification. These initial measurements give insights into 5G network propagation, creating data for use in more accurate network planning. Measurement data imported into the planning tool enables engineers to calibrate the propagation model, providing more accurate coverage prediction results.

5G gNB Field Test Solution

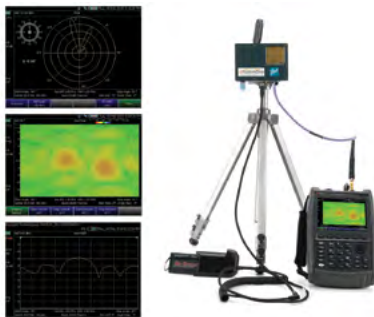

Keysight FieldFox handheld analyzer integrated with a phased array antenna

Keysight's 5G gNB Field Test solution, based on the FieldFox analyzer, provides complete tool kits for RF engineers and technicians to install and troubleshoot 5G networks. The solution serves as an all-in-one instrument with configurations including a spectrum analyzer, real-time spectrum analyzer, cable and antenna tester, and more. FieldFox LTE FDD and 5GTF OTA can measure PSS, SSS, and decode cell ID, which are key parameters to measure the effective 5G coverage.

5G Drive Test Solution



Nemo Outdoor 5G NR Drive Test Solution

Keysight's 5G Drive Test solution, Nemo Outdoor, enables mobile network operators to measure their 5G NR network coverage and quality. Monitoring and improving customer experience can help mobile network operators optimize their network and gain market share in their highly competitive environment. Nemo Outdoor is a powerful solution built on a single laptop-based software platform that gathers QoE metrics for a wide range of services and applications. Operators also use the information to verify, troubleshoot, and optimize new services and accelerate time to market.

5G Network Visibility Solution



Vision X

Accurate data processing and analysis requires network analysis tools that have visibility into all network. Data correlation to the subscribers and their applications is essential. However, data management is difficult due to the scale of mobile network activity — volume, velocity, and variety — leading to blind spots. Ixia Network Packet Brokers provide the ability to understand mobile traffic characteristics. The latest Vision X platform features mobile subscriber session awareness to support subscriber-aware data sampling and reduce processing volume while enabling operators to focus on critical traffic. The solution complements sampling with whitelist filtering capability to ensure the delivery of all traffic for high-value subscribers or first responders to your monitoring probes.

Keysight's Network Visibility solutions provide subscriber-aware visibility that enables mobile network monitoring solutions to scale to address 5G deployments. Ixia MobileStack can filter and forward specified subscriber sessions. Filtering and forwarding selected subscriber sessions to specific tools free up the resources of monitoring tools.

Section 6

Delivering the Bold Promise of 5G





Chapter 27 Insights Into the 5G Ecosystem

The 5G promise is exciting and real. Fifth-generation mobile networks are beginning to enable a variety of new technologies by bringing much faster data rates and unprecedented reliability to wireless communications. Say hello to lightning-fast downloads and real-time high-definition video streaming, smart farming, and optimal traffic management, and look forward to use cases such as autonomous vehicles and remote surgery. While these applications may feel far away, engineers working on 5G know that these capabilities are closer than many people think. Fixed broadband 5G emerged in 2018, delivering 5G home internet service to customers in select cities, and the 5G network buildout is in full swing. More than 200 operators in 85 countries are actively testing, performing trials, or deploying 5G.

5G technology is complex. Delivering on 5G's promise of increased speed, responsiveness, reliability, coverage, and flexibility requires a myriad of interconnected technological advancements. But engineers and technologists line up to confront any great challenge. To realize the potential of 5G, they are innovating with new design ideas, many of which will prove to be disruptive. For instance, engineers are tapping into higher frequencies in the mmWave spectrum because even the new bands available at lower frequencies cannot meet the needs of high-throughput 5G applications. Although the wider bandwidths available are attractive, radio propagation at these frequencies has a shorter reach and is more sensitive to interference. Engineers have designed advanced multi-antenna transmit and receive techniques to overcome these deficiencies, but this requires a change in test methods. OTA testing makes device characterization a lot more complicated.

Test methods on the other end of the mobile ecosystem also need to change. Network engineers need to implement challenging concepts like virtualization, multi-access edge computing, and control and user plane separation in the core network. While these technologies enable MNOs to prepare for the massive increase in subscribers 5G will bring, they also require new ways to test. Reducing the product and service lifecycle calls for much greater agility.

While engineers have solved many of the technical challenges of 5G, there are many more to come. Increased production demands will lead to faster manufacturing test innovations. Higher densities of latency-sensitive applications will lead to demands for faster mobile operator and data center networking tests. Disaggregated network applications will lead to changes in how we monitor and secure users. No matter what part of the mobile ecosystem you work in — from chipset development to device conformance through network deployment — you will need new insights to innovate and help your company win the coveted 5G opportunity. We are here to help.

Everywhere the electronic signal goes and data flows, Keysight is there to help innovators design, test, manufacture, and optimize their technology breakthroughs with trusted hardware and software solutions, services, and a global network of experts. Keysight's industry-first 5G end-to-end design and test solutions enable the mobile industry to accelerate 5G product design development from the physical layer to the application layer and across the entire workflow.

You can find more information and new resources at [keysight.com/find/5g](https://www.keysight.com/find/5g).

Appendix



5G Terms and Acronyms

The promise of 5G is faster and more reliable communications. 5G opens doors to exciting new connections to IoT networks, autonomous driving, broadband wireless, and interruption-free video viewing. Whatever you develop 5G technology for, it will be imperative to understand design and test concepts and solutions across multiple dimensions. There are a lot of 5G terms and more on the way. We've got you covered — here's a list of what's out there today.

2G

Second-generation digital cellular networks used by mobile phones, designed as a replacement for analog first-generation radio (1G). Designed primarily for voice using digital standards.

3G

Third-generation wireless mobile telecommunications technology, required by International Mobile Telecommunications for the year 2000 (IMT-2000) standard from International Telecommunication Union (ITU) to support at least 200 kbps at peak rate. First mobile broadband utilizing IP protocols added text and image messaging to voice phone calls.

3GPP – 3rd Generation Partnership Project

A mobile communications industry collaboration that organizes the development and management of mobile communications standards. With respect to 5G, 3GPP is managing the evolving 5G standards.

4G

Fourth-generation mobile telecommunications technology, designed to succeed 3G. A mobile broadband standard designed to support an all Internet Protocol (IP) network for calls, video, data, and web access. The performance goals of 4G are 100 Mbps for high-speed mobile applications such as automobiles, and 1 Gbps for low-mobility use cases including pedestrians and fixed-location access.

5G

Fifth-generation of mobile telecommunications technology, required by International Mobile Telecommunications for the year 2020 (IMT-2020) standard to support an all Internet Protocol (IP) network. Supports faster data rates, higher connection density, and much lower latency.

AAT – Antenna array tool

Software tool for embedding antenna parameters and radiation patterns in test scenarios.

ACP – Adjacent channel power

The power contained in a frequency channel next to the specified channel.

ACPR – Adjacent channel power ratio

The ratio of the power contained in a specified frequency channel bandwidth relative to the total carrier power.

ACLR – Adjacent channel leakage ratio

The ratio of the transmitted power on the assigned channel to the power received on the adjacent channel after passing through a root raised-cosine filter.

AM distortion

Undesirable distortion caused by amplitude variation in a communications system.

AMF – Access and mobility management function

A component of the 3GPP core network architecture that manages user equipment registration, authentication, identification, and mobility. AMF also terminates non-access stratum signaling.

AM/PM distortion

Undesirable distortion that causes signal degradation in a communications system, typically as the result of the interaction between an amplifier's phase response and the power level (or amplitude) of the input signal.

Antenna reciprocity

A theory that states that the transmit properties of an antenna will be identical to the receive properties of that antenna in a given medium.

AUSF – Authentication server function

A major component of the 5G core network used to facilitate security processes. The AUSF authenticates UEs and stores authentication keys.

AWG – Arbitrary waveform generator

Electronic equipment used to generate signals for injection into a device under test (DUT) to characterize its performance.

Backhaul

The part of the network responsible for transporting communication data between the baseband unit (BBU) and the core network. Connects smaller outlying networks with the core network. Backhaul was often proprietary in earlier cellular generations but is moving to ethernet in 5G.

Base station network emulator

A tool for simulating protocol and network traffic in a test environment. Works in concert with UE emulation and channel emulation to provide an end-to-end system for testing and measuring 5G network performance at scale.

BBU – Baseband unit

A component of the base station. Equipment which handles radio communications and radio control processing functions. The baseband unit converts data into a digital signal and sends it on to the remote radio head (RRH), which then converts it into an analog signal. In a C-RAN architecture, the baseband unit is usually geographically separated from the radio head.

Beam acquisition

The process of discovering and connecting with UEs. This process is substantially changing in 5G with the deployment of highly directional antenna arrays and beamforming techniques.

Beamforming

The method of applying relative phase and amplitude shifts to each antenna element to shape and provide discrete control of the direction of a transmitted beam. Beamforming requires communication channel feedback to implement real-time control of the beam.

Beam steering

A set of techniques used to focus the direction and shape of a radiation pattern. In wireless communications, beam steering changes the direction of the signal and narrows the width of the transmitted signal, typically by manipulating relative phase and amplitude shifts of the signal through an array of multiple antenna elements.

Carrier aggregation

A major feature introduced with LTE-Advanced, enabling mobile network operators to combine multiple carriers in fragmented spectrum bands to increase peak user data rates and overall capacity of the network.

CATR – Compact antenna test range

Equipment for testing of antennas at frequencies when difficult to obtain far-field spacing. The CATR uses the 3GPP-approved indirect far-field (IFF) test method to overcome the path loss and excessive far-field distance issues associated with 5G cellular communications.

CE – Channel emulator

Electronic equipment that enables real-time performance testing of wireless devices and base stations. Channel emulators simulate the impairments of real-world radio channel conditions to validate the performance of base stations, chipsets, and devices.

Cell tower

Physical location of electronic communications equipment, including antennas to support cellular communication in a network.

CIR – Channel impulse response

The correlation of the received signal against the transmitted signal during testing.

CoMP – Coordinated multipoint

A technique where multiple base stations can coordinate downlink transmission (from base station (BS) to user equipment (UE)) and uplink transmission (UE to BS) to improve the overall reliability and performance.

Control plane

The part of a network that carries information that establishes and controls the network. It controls the flow of user information packets between network interfaces.

Core network

The part of the network that provides services to mobile subscribers through the radio access network (RAN). It is also the gateway to other networks, for instance to the public-switched telephone network or public clouds.

CPE – Common phase error

A measurement of noise in orthogonal frequency division multiplexing (OFDM). CPE describes the average of the phase noise sequence spanning an OFDM symbol.

CP-OFDM – Cyclic prefix orthogonal frequency division multiplexing

An orthogonal frequency division multiplexing (OFDM) technique that uses cyclic prefixes (CP) instead of null guards, protecting OFDM signals from intersymbol interference (ISI).

CPRI – Common public radio interface

An interface specification standard that defines a layer-1 and layer-2 interface for connecting radio equipment such as radio heads on towers to other radio equipment control infrastructure located at the base of the tower or in a centralized facility.

C-RAN – Centralized RAN

A radio access network (RAN) architecture that separates baseband functions from antennas and remote radio heads (RRH) and pools baseband functions in centralized baseband units (BBU). A competing architecture to multi-access edge computing (MEC).

CRS – Cell-specific reference signal

A signal transmitted to estimate the channel between the base station and the user equipment as a reference point for downlink power.

CSI – Channel state information

Refers to known properties of a communication link. 5G NR specifies a new beam management framework for CSI acquisition to reduce coupling between measurements and reporting to control different beams dynamically.

CUPS – Control user plane separation

Foundational concept for 5G networks that enables operators to independently scale the control plane and user plane of the mobile network as needed.

Data plane

The part of a network through which user packets are transmitted. It is often included in diagrams and illustrations to give a visual representation of user traffic. Also known as the user plane, forwarding plane, or carrier plane.

DFF – Direct far field

An over-the-air (OTA) test method used in 5G that involves mounting the device under test (DUT) on a positioner that rotates in azimuth and elevation. This process enables measurement of the DUT at any angle on the full 3D sphere. The DFF method can perform the most comprehensive tests measuring multiple signals and requires a larger test chamber for mmWave devices.

DFT-s-OFDM – Discrete Fourier transform spread orthogonal frequency division multiplexing

An optional modulation format used in the uplink in 5G NR. DFT-s-OFDM uses the mathematical concept of discrete Fourier transform to encode digital data on multiple frequency channels in a frequency division multiplexing scheme, increasing bandwidth, and decreasing response time.

DL – Downlink

The path of transmission from the base station to the user equipment (UE). In 5G, the DL waveform is orthogonal frequency division multiplexing (OFDM).

DUT – Device under test

Device under test (DUT), equipment under test (EUT), system under test (SUT) and unit under test (UUT) are terms used to refer to a device undergoing measurement procedures.

EIRP – Effective isotropic radiated power

An IEEE standardized definition for the measurement of the radiated power of an antenna in a specific direction.

eLTE eNB

An evolved 4G eNodeB (or eNB) that can support connectivity to the 4G evolved packet core (EPC) as well as the 5G next-generation core network (NGC or NGCN).

eMBB – Enhanced mobile broadband

One of three primary use cases defined in the IMT-2020 vision. Enhanced Mobile Broadband refers to target 5G peak and average data rates, capacity, and coverage as compared to conventional mobile broadband (MBB). eMBB specifies a 5G design capable of supporting up to 20 Gbps in the downlink, and 10 Gbps in the uplink.

eNB – Evolved Node B or eNodeB

Base stations connected to the network that communicate wirelessly with mobile handsets in a 4G LTE network or 5G non-standalone (NSA) mode.

EN-DC – E-UTRAN New Radio – dual connectivity

A term for the simultaneous 4G LTE and 5G NR connectivity prescribed by 3GPP Release 15. EN-DC enables user equipment to connect simultaneously to an LTE base station and a 5G base station.

EPC – Evolved packet core

The core network of the 4G LTE system, the EPC features a flat architecture to handle voice and data efficiently. It requires a few network nodes to be involved in the handling of traffic. EPC serves as an anchor in initial implementations of 5G fixed wireless access (FWA).

EPS – Evolved packet system

Evolved end-to-end-architecture composed of the base station and evolved packet core (EPC) that enables 4G mobile communication.

ERTA – Extended range transmission analysis

A technique used to measure the scalar transmission gain or loss of an RF system.

E-UTRAN – Evolved UMTS terrestrial radio access network

A new radio interface specified by the 3GPP consortium and introduced with LTE in 2008. It was designed to meet ever-increasing data transfer rates while reducing the radio operation latency.

EVM – Error vector magnitude

Error vector magnitude is a measurement used to quantify the quality of a digital radio signal. The measurement is a representation of how far the actual signal deviates from an ideal representation of that same signal.

FBMC – Filter bank multicarrier

A form of multicarrier modulation that deploys without synchronization of mobile user nodes signals. It offers better usage of available channel capacity, higher data rates within a given spectrum bandwidth, and higher spectrum efficiency. FBMC is considered inferior to orthogonal frequency division multiplexing (OFDM) in handling multiple-input/multiple-output (MIMO) channels.

FDD – Frequency division duplex

Using two different radio frequencies for transmitter and receiver operation to establish a full-duplex communications link.

FD-MIMO – Full dimension MIMO

A MIMO technique added to the 3GPP specification with LTE-Advanced Pro (Release 13). FD-MIMO extends MIMO concepts to work in three dimensions: azimuth (horizontal), control (range), and elevation (vertical).

FPY – First pass yield

Metric describing the number of finished units compared to the number of units that went into the manufacturing process. FPY is a critical metric for device makers and is likely to decline with the complexities of 5G.

FR1 – Frequency range 1

One of two frequency ranges prescribed by 5G NR. FR1 covers sub-6 GHz frequency bands, including some used by previous standards. FR1 also covers potential new spectrum offerings between 410 MHz and 7125 MHz.

FR2 – Frequency range 2

The second of two frequency ranges prescribed by 5G NR; FR2 includes the millimeter wave (mmWave) frequencies between 24.25 GHz and 52.6 GHz. Bands in FR2 have a shorter range and higher available bandwidth compared to bands in FR1.

Fronthaul

Refers to links in the C-RAN that connect radio equipment at the tower with centralized radio controllers (radio equipment control). Fronthaul data is generally transported over fiber optics using the CPRI (common public radio interface) standard. Each manufacturer has a proprietary overlay to CPRI that exclusively requires that vendor's equipment on both ends of the link.

FWA – Fixed wireless access

A type of wireless broadband data communication between two fixed locations and connected through wireless access points and equipment.

GCF – Global Certification Forum

An independent organization that provides certification for mobile phones and wireless devices that use 3GPP standards.

gNB – gNodeB

5G wireless base stations that transmit and receive communications between the user equipment and the mobile network.

GPRS – General packet radio services

A packet-based wireless communication standard for delivering data to mobile devices via a cellular connection.

HD – Half duplex

A two-party communication system for exchanging voice or data, where only one node can speak at a time.

Harmonic

A signal at a frequency that is an integer multiple of another reference signal. The respective harmonic signal can be termed as $2f$, $3f$ and so on where f is the frequency of the reference signal.

HSS – Home subscriber server

Common database of subscriber information, keeps authentication information as well as permissions (e.g., authentication, authorization, and accounting (AAA) server).

ICI – Intercarrier interference

Channel variations during an orthogonal frequency division multiplexing (OFDM) sequence caused by carrier frequency offsets, channel time variation, and sampling frequency offsets. ICI degrades the performance of OFDM transmissions.

IFBW – Intermediate frequency bandwidth

The bandwidth of the frequency that a carrier wave shifts to as an intermediate step in transmission or reception.

IFF – Indirect far field

A test method approved by 3GPP to overcome path loss and excessive far-field distance involved in 5G cellular communications.

IMEI – International mobile equipment identity

A number that uniquely identifies 3GPP mobile devices. Used by the telecommunications network to identify valid devices in case of loss or theft.

IMSI – International mobile subscriber identity

A unique number that identifies the subscriber identification module (SIM) card present in the device belonging to a subscriber.

IMT-2020 – International Mobile Telecommunications-2020

A standard that sets the requirements for 5G networks, devices, and services. IMT-2020 was developed by the International Telecommunications Union (ITU) Radiocommunication Sector in 2015. The ITU is a United Nations agency responsible for information and communications technologies.

ISI – Intersymbol interference

Signal distortion caused when one or more symbols interfere with other symbols. Caused by amplitude and phase dispersion in the channel due to multipath propagation or non-linear frequency response.

ITU – International Telecommunication Union

A United Nations agency responsible for information and communications technologies. The ITU — formerly called the International Telegraph Union — is the oldest global international organization, established in 1865. The ITU created the standard that sets forth the requirements for 5G networks, devices, and services known as IMT-2020.

KPIs – Key performance indicators

Metrics that quantify how mobile phones and other user equipment performs on a network.

Layer 1

The Open Systems Interconnect (OSI) model has seven layers: Layer-1 is the Physical Layer and governs the transmission of data in a point to point or broadcast connection, with a focus on electrical, optical, or RF transmission properties.

Layers 2/3

The Open Systems Interconnect (OSI) model has seven layers: Layer-2 is the Data Link layer and Layer-3 is the Network layer. Together they are responsible for setting up connectivity between hosts, framing the information, and routing information to the right destination. Each layer serves the layer above it and is served by the layer below it.

Layers 4-7

The Open Systems Interconnect (OSI) model has seven layers: Layers 4-7 implement data exchange between relatively distant systems. Layer-4 is the Transport, Layer 5 is the Session layer, Layer-6 is the Presentation layer, and Layer-7 is the Application layer. Each layer serves the layer above it and is served by the layer below it.

LO – Local oscillator

An electronic component used for changing the frequency of a signal.

LoS – Line of sight

Refers to a system where transmitter and receiver are in view of each other without any obstruction. AM/FM radio, satellite transmission, and police radar are examples of line-of-sight communication.

LTE-Advanced – Long-term Evolution Advanced

Also known as “LTE Release 10,” LTE-A is one of the two mobile communication platforms officially designated by the International Telecommunication Union (ITU) as the first 4G technology (the other is LTE-Advanced Pro). It specifies data rates of 500 Mbps maximum upload speed and 1 Gbps maximum download speed with a latency (round-trip) of 5 ms.

LTE-Advanced Pro

Also known as 4.5G, 4.5G Pro, 4.9G, pre-5G, its feature functionality is defined in 3GPP Release 13 and 14. An evolution of Long Term Evolution (LTE) with speeds up to 1 Gbps. LTE-Advanced Pro incorporates new functionality including 256 QAM, FD-MIMO, LTE-Unlicensed, LTE IoT, and other technologies to evolve existing networks towards the 5G standard.

LTE-LAA – Long-term Evolution Licensed Assisted Access

Part of 3GPP Release 13 and a feature of LTE Advanced Pro. It uses carrier aggregation in both the unlicensed (5 GHz) and licensed spectrums to increase peak user data rates and overall capacity of the network.

Massive MIMO

An extension of MIMO, using more transmit and receive antennas to increase transmission gain and spectral efficiency. There is currently no set minimum scale, though a system with greater than 8 transmit and 8 receive antenna is generally considered the threshold for massive.

MC – Multicarrier

Process of splitting data into multiple components and transmitting via separate carrier signals. This method offers reduced susceptibility to several effects that can degrade signal integrity, including multipath fading, interference caused by impulse noise, and inter-symbol interference.

MCC – Mobile country code

A unique identifier used in conjunction with a mobile network code (MNC) to identify a mobile network operator.

MEC – Multi-access edge computing

A network architecture where more processing, especially for latency-sensitive applications, stays closer to the edge of the mobile network. A competing architecture to Centralized RAN (C-RAN).

MIMO – Multiple-input/multiple-output

An antenna diversity technique using multiple antennas on both the transmit side and receive side to take advantage of multi-path propagation and improve the quality and reliability of wireless communication.

MIPI – Mobile industry processor interface

A collection of more than 45 standard mobile industry specifications designed to accelerate development of mobile and mobile-influenced products, most commonly used in mobile handsets.

mMTC – Massive machine-type communications

One of three primary 5G use cases defined in the IMT-2020 vision, massive machine-type communications supports 5G IoT use cases with billions of connected devices and sensors. The use case is characterized by low bandwidth and infrequent bursts of data, requiring long-life batteries.

mmWave – Millimeter wave

The band of spectrum between 30 GHz and 300 GHz where the wavelength is on the order of millimeters. Between the microwave and infrared spectrums, mmWave is used for high-speed wireless communications.

MNC – Mobile network code

A unique identifier used in conjunction with a mobile country code (MCC) to identify a mobile network operator.

MU – Measurement uncertainty

A statistical representation of the accuracy of a measurement.

MU-MIMO – Multiple user, multiple-input/multiple-output

An application of multiple-input / multiple-output (MIMO) technologies where the base station communicates with two or more UEs simultaneously.

NEF – Network exposure function

A function of the 3GPP core network architecture that provides a means to securely expose capabilities and events. NEF stores the received information as structured data and exposes it to other network functions.

NEMs – Network equipment manufacturers

Firms that build network equipment for service providers to manage their networks.

NFTF – Near-field to far-field transform

A method for over-the-air (OTA) mmWave testing that samples the phase and amplitude of the electrical field in the near region and uses math to predict the far-field pattern. While this is a compact, low-cost method, it is subject to transmitter interference that impacts measurement accuracy.

NGC/NGCN – Next Generation Core / Next Generation Core Network

The 5G next generation core network. NGC or NGCN is the part of the network that provides services to mobile subscribers through the radio access network (RAN). It is also the gateway to other networks, for instance to the public-switched telephone or to public clouds.

NLOS – Non-line of sight

An RF signal path that is obscured by obstacles. Common causes for non-line-of-sight include obstacles such as buildings, trees, hills, and mountains.

NSA NR – Non-standalone NR

A 5G network deployment that uses existing 4G LTE radio and evolved packet core network control plane but also allows carriers to begin early trials using 5G UEs and 5G data (or user) plane.

NR – New Radio

Shorthand for “5G NR.” 5G NR is the standard for a new OFDM-based air interface designed to support 5G devices, services, deployments, and spectrum. NR is used to describe 5G in the same way LTE is used to describe 4G. The 3GPP has three areas of focus for 5G NR: Enhanced mobile broadband (eMBB), massive machine-type communications (mMTC), and ultra-reliable low-latency communications (uRLLC).

NRF – Network repository function

A component of the 3GPP architecture that provides service discovery between individual network functions.

NSSF – Network slice selection function

3GPP architecture function that selects the set of network slice instances serving the user equipment and determines which access and mobility management function to use.

Numerology

Refers to how cellular communications waveforms are created based on underlying structures. The 5G NR specification permits flexible numerology, meaning the OFDM frame can have variable subcarrier spacing, symbol timing, and flexible usage of symbol slots. 5G NR permits different numerologies to be transmitted on the same carrier frequency.

NV IOT – Network vendor interoperability testing

Testing among vendors of network hardware and software to verify the interfaces between their network elements prior to software release in operator networks.

OBW – Occupied bandwidth

The bandwidth containing 99% of the total integrated power of the transmitted spectrum, centered on the assigned channel frequency.

OFDM – Orthogonal frequency division multiplexing

A frequency division multiplexing scheme encoding digital data on multiple frequency channels to increase bandwidth and decrease response time. OFDM techniques allow for densely packed sub-carriers without the need for guard bands and filters, increasing spectral efficiency and simplifying electronic design. OFDM is especially good in severe channel conditions where narrowband interference exists.

OQAM – Offset quadrature amplitude modulation

A group of digital modulation schemes that conveys two digital bit streams by modulation the amplitude of carrier waves. The carrier waves are of the same frequency but out of phase with each other by 90 degrees, enabling simple demodulation at the receiver.

OTA – Over-the-air

Testing the RF performance, demodulation, or RRM (radio resource management) through the air interface, versus a cabled connection; often performed in an anechoic chamber.

PAPR – Peak to average power ratio

The ratio of the peak power of a signal to that signal's average power.

PCF – Policy control function

Element of the 3GPP core network architecture that provides policy rules to control plane functions.

PGW – Packet data network gateway

Equipment in the 4G LTE evolved packet core which connects the LTE network to other packet data networks.

Phased array antenna

Phased array antennas are a means of creating narrow beams and dynamically pointing them in the desired direction without mmWave antennas used for 5G base stations and UEs. A phased array antenna is formed by an array of smaller antenna elements, such as individual patches or dipoles. By varying the relative phases and amplitudes of the signals applied to the individual elements, the antenna array can shape and steer a beam in a chosen direction.

Picocell

A small cellular base station that is an alternative to a repeater or distributed antenna system to improve mobile phone reception indoors.

P-OFDM – Pulse-shaped orthogonal frequency division multiplex

An orthogonal frequency division multiplexing scheme that uses pulse-shaped multicarrier waveforms, offering comparatively high waveform robustness with low out-of-band emissions and interference.

PSS – Primary synchronization signal

The second component of the synchronization signal block used for synchronizing user equipment with a base station.

PTCRB – PCS Type Certification Review Board

A certification forum established by major North American service providers.

QAM – Quadrature amplitude modulation

A modulation scheme with both digital and analog components. QAM doubles the effective bandwidth by combining two amplitude-modulated waveforms onto a single carrier.

QoE – Quality of experience

A measure of the overall level of customer satisfaction with the network as measured by various success factors including ease of use, reliability, security, and cost.

QoS – Quality of service

A measure of the network's ability to achieve specific performance thresholds for latency, error rate, and uptime.

RACH – Random access channel

A channel shared among wireless devices to access the mobile network for call setup and data transmission bursts such as text messages.

RAN – Radio access network

The part of the telecommunications network that connects user equipment to other parts of a mobile network via a radio connection. Connects user equipment to the core network.

RAT – Radio access technology

The underlying physical connection method for a radio-based communication network. Modern phones may support several RATs in one device such as Bluetooth, Wi-Fi, NFC (Near-Field Communications), and 3G, 4G or LTE, and 5G.

RRH – Remote radio head

The component of a base station responsible for converting the digital signal into an analog signal for transmission. The remote radio head is usually located on the tower in proximity to the antenna(s) to minimize signal loss.

RRM – Radio resource management

The management of radio resources and transmission characteristics such as modulation scheme, transmit power, beamforming, user allocation, data rates, handover criteria, and error coding scheme.

Rx – Receive

In wireless communications, the process of converting incoming transmissions into perceptible communications.

SBA – Service-based architecture

Type of architecture standardized by 3GPP for 5G core networks. The 3GPP defines an SBA to include service-based interfaces between control plane functions, with user plane functions connecting over point-to-point links.

SC – Single carrier

A transmission that uses a single radio frequency carrier to transmit all data.

SDN – Software-defined networking

An approach using open protocols for remote configuration of network switches and routers.

SEM – Spectrum emissions mask

A relative measurement of the out-of-channel emissions to the in-channel power. SEM measurements calculate the excess emissions that interfere with other channels or systems.

SFI – Slot form indicator

Indicates how each of the orthogonal frequency division multiplexing (OFDM) symbols within a given slot is used. The SFI denotes whether a given OFDM symbol in a slot is used for uplink or downlink, or if it is flexible.

SMF – Session management function

A fundamental element of the 5G service-based architecture (SBA) that establishes and manages sessions. It also selects and controls the user plane function and handles paging.

SNIR – Signal-to-noise and interference ratio

The power of the signal divided by the sum of interference power from competing signals and the power of the background noise present. SINR is used to describe the theoretical upper limit of channel capacity.

SNR – Signal-to-noise ratio

The ratio of the strength of the signal to interference usually expressed in decibels.

SS-RSRP – Synchronization signal reference signal received power

The average of the power of the resource elements that carry the synchronization signal.

SS-RSRQ – Synchronization signal reference signal received quality

A measurement of the received quality of the synchronization signal.

SS-SINR – Synchronization signal signal-to-interference-plus-noise ratio

The power of the synchronization signal divided by the sum of the interference from competing signals and the background noise present.

SSS – Secondary synchronization signal

The second component of the synchronization signal block used for synchronizing user equipment with a base station.

Standalone NR

A 5G network deployment configuration where the gNB does not need any 4G assistance for connectivity to the core network; the 5G UE connects to the 5G next generation core network (NGC or NGCN).

SU-MIMO – Single user, multiple-input / multiple-output

An application of multiple input and multiple output (MIMO) technologies for wireless communication, in which the base station communicates with only one UE during the allotted time slice.

TDD – Time division duplex

Duplex communication where the uplink is separated from downlink by different time slots in the same frequency band.

TT – Test tolerance

The allowable error of a measurement's accuracy.

Transmit diversity

A technique to diminish the effects of fading by transmitting the same information from two or more independent sources.

TRX – Transceiver

A device that can both transmit and receive signals.

TTI – Transmission time intervals

The duration of transmission allowed for a frame on a mobile network. 5G NR allows for different transmission time durations based on the unique requirements of a class of traffic, creating differentiated classes of service, similar to those found on an IP network.

Tx – Transmit

In wireless communications, the act of sending data through the air from one device to another device or group of devices.

UDM – Unified data management

A significant component of the 5G core network that stores subscriber data and profiles.

UE – User equipment

A subscriber's mobile device, such as a cell phone, tablet, or modem.

UE emulation

The simulation of subscriber user equipment (UE) usage behaviors.

UF-OFDM – Universal filtered orthogonal frequency division multiplexing

A form of orthogonal frequency division multiplexing (OFDM) modulation that improves out-of-band (OOB) characteristics by filtering the frequency band.

UL – Uplink

The path of transmission from the UE to the base station. In 5G, the uplink waveform is CP-OFDM or DFT-s-OFDM.

UPCL – Uplink classifier

Network functionality supported by the user plane function (UPF) that diverts traffic to local data networks based on filters applied to the user equipment traffic.

UPF – User plane function

The 5G equivalent of the packet gateway in a 4G LTE network. The user plane function includes features to support packet routing and forwarding, interconnection to other data networks, and policy enforcement. Also known as the data plane.

URLLC – Ultra-reliable low-latency communications

One of three key use cases defined in 5G NR. URLLC focuses on applications that require fail-safe, real-time communications. Examples include remote surgery, industrial internet, smart grids, infrastructure protection, intelligent transportation systems and autonomous vehicles.

UW-OFDM – Unique word orthogonal frequency division multiplexing

An orthogonal frequency division (OFDM) multiplexing technique that uses an arbitrary deterministic sequence as the guard interval rather than the random cyclic prefixes used in cyclic prefix OFDM (CP-OFDM). UW-OFDM provides the same benefits as CP — including protecting the OFDM signals from intersymbol interference (ISI). CP-OFDM offers benefits for synchronization and channel estimation purposes since it uses known sequences.

V2X – Vehicle-to-everything

The passing of information between vehicles and roadway infrastructure to facilitate road safety and traffic efficiency.

vEPC – Virtual EPC

A core network in an LTE system built with SDN-enabled white-box switches and virtual network functions instead of purpose-built hardware.

VSG – Vector signal generator

Electronic equipment that generates digitally modulated signals for testing and measuring digital components and receivers.

VSWR – Voltage standing wave ratio

The ratio of maximum to minimum voltage in a transmission.

VVM – Vector voltmeter

Electronic equipment that measures the phase and voltage of two input signals of the same frequency.

WCDMA – Wideband code division multiple access

A 3G standard for a radio communication system that provides high-speed data and voice communication services.

W-OFDM – Windowed orthogonal frequency division multiplexing

An orthogonal frequency division multiplexing (OFDM) technique where each symbol is windowed and overlapped in the time domain, reducing the spectral sidelobes.

Xn Interface

A logical interface that interconnects RAN nodes. That is, it interconnects gNB to gNB and eLTE eNB to gNB and vice versa.

Technical Contributors



Javier Campos
NR Physical Layer Architect / RAN1 Delegate
Keysight Technologies, Inc.

Javier Campos has more than 15 years of experience in physical layer design and digital communications. He has worked with several companies in the industry, including AT4 Wireless and Xingtera, where he focused on technologies such as LTE and G.hn PLC. Since joining Keysight in 2012, Javier has actively worked in physical layer architecture and design for LTE, NB-IOT, 5GTF, and 5G-NR as well as created and delivered 5G-NR physical layer educational content. Javier has represented Keysight in 3GPP RAN1 meetings since 2016. He holds an MSc in Telecommunications Engineering from the University of Malaga, Spain.



Greg Jue
5G System Engineer
Keysight Technologies, Inc.

Greg Jue is a 5G System Engineer at Keysight Technologies working on emerging millimeter-wave applications beyond 50 GHz. Greg has worked in Keysight's 5G team, Aerospace/Defense applications team, High Performance Scopes team, and in EEsof, specializing in 5G, WLAN 802.11ac, LTE, WiMAX, Aerospace/Defense, and SDR applications. Greg wrote the design simulation section in Agilent Technologies LTE book, and has authored numerous articles, presentations, application notes, and whitepapers including Keysight's "Implementing a Flexible Testbed for 5G Waveform Generation and Analysis". Greg pioneered combining design simulation and test solutions at Agilent Technologies, and has authored many application notes on combining simulation and test for emerging technologies. Before joining HP/Agilent in 1995, he worked on system design for the Deep Space Network at the Jet Propulsion Laboratory, Caltech University.



Mike Millhaem
5G Technical Architect
Keysight Technologies, Inc.

Mike Millhaem has been the Keysight 5G Technical Architect since 2015. In this position Mike has worked to develop new test architectures for massive MIMO and FR2 infrastructure and user equipment. Prior to his current position, Mike has worked in engineering and marketing for test systems targeted at communications and aerospace defense systems and components. Mike holds a BSEE from the University of Illinois, Champaign-Urbana.



Roger Nichols
5G Program Manager
Keysight Technologies, Inc.

Roger Nichols has been directing Keysight's 5G Programs since 2014. His 35 years of engineering and management experience in wireless test and measurement at Hewlett-Packard, Agilent Technologies, and Keysight spans roles in manufacturing, R&D, and marketing. He has worked on programs and projects starting with analog cellular radio, evolving to 5G, and on every standard in between. He spent seven years as the Senior Marketing Director for Keysight's (Agilent's) Mobile Broadband Division responsible for the wireless test-sets and systems used in all major 2G and 3G design and certification labs and manufacturing facilities worldwide. Roger is also directing Keysight's wireless standards strategies and Keysight's over-the-air measurement development programs. Roger holds a BSEE from the University of Colorado, Boulder.



Kalyan Sundhar
Vice President and General Manager of 5G Edge To Core Group
Keysight Technologies, Inc.

Kalyan Sundhar has over 25 years of experience in the industry, leading multi-national teams that develop products for operators, network equipment manufacturers, and test and measurement vendors. He is currently vice president and general manager of the 5G Edge To Core Group. In this role, Kalyan is responsible for working with key customers on technical and business fronts – defining the strategy, roadmap, and go-to-market plans from 5G RAN to Core. Previously, Kalyan was responsible for creating and executing Ixia's wireless and virtualization strategies across all product lines, as well as overseeing the development of Ixia products relating to 5G, LTE, Wi-Fi, and applications in the voice, video, and data areas. He holds several patents in the wireless area. He co-authored the popular "5G for Dummies" book, and is a regular contributor to several leading magazines in this space.

Editors

Jessy Cavazos and Dylan McGrath

Managing Editor

Nicole Faubert

